

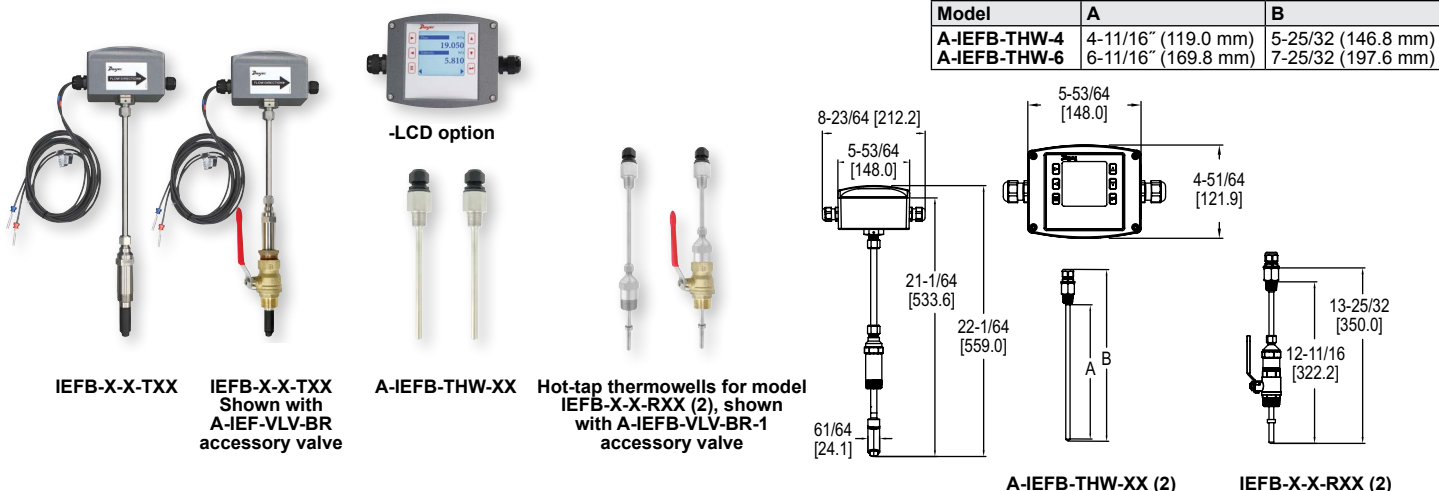

## Series IEFB Insertion Thermal Energy Meter

### Specifications - Installation and Operating Instructions



The **Series IEFB Insertion Thermal Energy Meter** is a field-adjustable insertion thermal energy meter that uses electromagnetic technology to accurately and reliably measure fluid velocity and energy consumption. The high accuracy IEFB is adjustable to fit pipe sizes from 4 to 10" (100 to 250 mm), while the standard accuracy IEFB fits pipe sizes 4 to 36" (100 to 900 mm). The flowmeter is simple to install and incorporates a temperature meter and an energy calculator into a single unit. The LCD display provides precise readings of the meter's values, including temperature and energy consumption, making it ideal for installation on chillers, boilers, and other heating and cooling applications. The meter's high measuring accuracy and long lifetime keeps annual system operating costs at a minimum. In addition, it offers several output options, including selectable BACnet MS/TP or Modbus® RTU communications protocol over 2-wire RS-485 and standard analog, frequency, and alarm outputs.

#### FEATURES/BENEFITS

- Flexible, field configurable setup displays (-LCD integral option or remote accessory A-IEF-DSP) accommodate a variety of application configurations. Application information is display selectable and includes pipe size, pipe material, liquid type, analog output, pulse/frequency output, alarm outputs, communication outputs, damping, and calibration factor
- High performance accuracy is maintained through changes in temperature, density and/or viscosity
- The Setup Wizard and installation tool are simple to use, providing quick and precise installation
- Accessory setup kit A-IEF-KIT comes with a thickness gage and measuring tape to ensure exact installation depth
- The meter has no moving parts and electrodes that discourage fouling, which gives the meter a long lifecycle and minimizes the need for maintenance
- Hot-tap isolation valve accessories allow for easy installation and removal in operational systems without system downtime

#### APPLICATIONS

- Monitoring chiller cooling output performance
- Industrial boiler heating performance
- Energy efficiency monitoring
- Optimization of heat energy performance
- Commercial and residential heat energy consumption and metering
- District heating and cooling monitoring
- Energy cost allocation monitoring

#### SPECIFICATIONS

**Service:** Compatible clean or dirty non coating, conductive liquids.

**Range:** 0 to 20 ft/s (0 to 6 m/s)\*

**Wetted Materials:** Body shaft/fitting: 316 SS; Electrodes: 316 SS; Electrode cap: Polymer/polystyrene; O-ring: Silicone; Thermowells: 304 SS.

#### BTU Accuracy per EN1434/ASTM

**E3137/CSA C900.1-13:** High Accuracy Units: Class 2 for 2 to 20 ft/s (0.6 to 6 m/s)\*\*; Standard Accuracy Units: Class 3 for 6.5 to 20 ft/s (2 to 6 m/s)\*\*.

**Flow Sensor Accuracy:** High Accuracy Units:  $\pm 0.5\%$  of reading at calibrated velocity,  $\pm 1\%$  of reading from 2 to 20 ft/s (0.6 to 6 m/s)  $\pm 0.02$  ft/s ( $\pm 0.006$  m/s) at  $< 2$  ft/s (0.6 m/s); Standard Accuracy Units:  $\pm 1\%$  FS.

**Temperature Accuracy:** Class B  $\pm(0.30 + 0.005 \cdot t)^\circ\text{C}$  per EN60751.

**Differential Temperature Accuracy:**  $E_t = \pm(0.5 + 3 \cdot \Delta\theta_{\text{min}}/\Delta\theta) \%$  per EN1434.

**Calculator Accuracy:**  $E_c = \pm(0.5 + \Delta\theta_{\text{min}}/\Delta\theta) \%$  per EN1434.

**Temperature Compensation:** 140 to 220°F (60 to 104.4°C)  $< 2\%$  error over  $\pm 30^\circ\text{F}$  ( $-1.1^\circ\text{C}$ ) change, 40 to 70°F (4.4 to 21.1°C)  $< 2\%$  error over  $\pm 10^\circ\text{F}$  ( $-12.2^\circ\text{C}$ ) change.

**Temperature Limits:** Ambient: -20 to 160°F (-29 to 71°C), -LCD -4 to 158°F (-20 to 70°C); Process: 15 to 250°F (-9 to 121°C); Storage: -40 to 185°F (-40 to 85°C).

**Process Connection:** Flowmeter: 1" NPT or BSPT with accessory full port ball valve options; Thermowell: (2) 1/2" NPT or BSPT thermowell with 1" full port ball valve options.

**Pressure Limit:** 400 psi (27.6 bar) @ 100°F (37.8°C).

**Pressure Drop:**  $< 0.1$  psi at 12 ft/s in 4" ( $< 0.01$  bar at 3.7 m/s in 100 mm) and larger pipe.

**Outputs:** (1) Analog: 4-20 mA, 0-5 V, 0-10 V or 2-10 V (display selectable); (1) Pulse/Frequency: 0-15 V peak pulse, 0-500 Hz or scalable pulse output (display selectable); (2) Alarm: Empty pipe detection or minimum/maximum velocity, (display selectable) & Reverse flow output indication.

\*For max flowrates  $> 10$  ft/s (3 m/s) order option -CC.

\*\* Verified at standard temperature 73.4°F (23°C) refer to listed standards for detailed accuracy formulations.

**Power Requirements:** 12-42 VDC, .25 A @ 24 VDC; 12-36 VAC.

**Electrical Connection:** Removable terminal blocks, (2) model selectable 1/2" female NPT conduit connection, (2) PG 16 gland or (2) PG 16 gland with 10 ft (3 m) 9 conductor 22 AWG plenum rated cables, accessory cable lengths up to 200 ft (61 m) optional.

**Display (-LCD option):** 2 x 2" (50 x 50 mm) graphic LCD with backlight.

**Conductivity:**  $> 20$  microsiemens.

**Enclosure Material:** Powder coated die cast aluminum.

**Enclosure Ratings:** NEMA 6P (IP68) (Non display models); NEMA 4X (IP66) (-LCD option).

**Compliance:** BTL.

#### COMMUNICATIONS (-COM OPTION)

**Type:** BACnet MS/TP or Modbus® RTU communication protocol (default disabled, display selectable).

**Supported Baud Rates:** 9600, 19200, 38400, 57600, 76800, or 115200 bps (display selectable).

**Device Load:** 1/8 unit load.

#### ADDITIONAL SPECIFICATIONS

**Applicable Pipe Material:** Most popular plastic and metal pipes; i.e. Carbon steel, SS, copper, UPVC/PVDF, galvanized steel, mild steel, and brass.

**Applicable Pipe Size:** 4 to 36" (100 to 900 mm), model dependent. See model chart.

**Diameter Length Requirements:**  $> 10$  upstream,  $> 5$  downstream.

**Temperature Resistance:** Matched 4 wire platinum RTD's.

**Relative Humidity:** 10 to 90% non-condensing.

**Output Impedance:** 4-20 mA: 536  $\Omega$ ; 5V: 500  $\Omega$ ; 10V: 1.27k  $\Omega$ .

MODEL CHART						
Example	IEFB	-L	N	-CND	-R10	-LCD
Series	IEFB					
Accuracy		L G S F I E T H				
Process Connection			N B			
Housing Electrical Connection				CND PG 10		
Temperature Sensors				T10 T20 T50 R10 R20 R50		
Options					LCD COM NIST FC CC	
*Thermowells not included. Refer to thermowell accessory model chart to purchase permanent thermowells.						

ACCESSORIES	
Model	Description
<b>Thermowells</b>	
A-IEFB-THW-4	(2) 1/2" NPT, 4" (100 mm) thermowell for 4 to 7" (100 to 175 mm) pipe*
A-IEFB-THW-6	(2) 1/2" NPT, 6" (150 mm) thermowell for ≥8" (200 mm) pipe**
A-IEFB-THW-4-BSPT	(2) 1/2" BSPT, 4" (100 mm) thermowell for 4 to 7" (100 to 175 mm) pipe
A-IEFB-THW-6-BSPT	(2) 1/2" BSPT, 6" (150 mm) thermowell for ≥8" (200 mm) pipe
<b>Hot-Tap Valves</b>	
A-IEFB-VLV-BR-1	(2) 1" NPT full port isolation valve brass for temperature sensor with 1" branch outlet and 1" nipple
A-IEFB-VLV-SS-1	(2) 1" NPT full port isolation valve 316 SS for temperature sensor with 1" branch outlet and 1" nipple
A-IEFB-VLV-BR-1-BSPT	(2) 1" BSPT full port isolation valve brass for temperature sensor with 1" branch outlet and 1" nipple
A-IEFB-VLV-SS-1-BSPT	(2) 1" BSPT full port isolation valve 316 SS for temperature sensor with 1" branch outlet and 1" nipple
*4" (100 mm) standard thermowells for 1-1/2" stack height: 4 to 7" (100 to 175 mm) pipe size	
**6" (150 mm) standard thermowells for 1-1/2" stack height: 8 to 10" (200 to 350 mm) pipe size. Ideal insertion depth is 3" (80 mm)	

### Safety Information

#### WARNING

- Only qualified professionals equipped with the necessary required trade skills should install, remove or service this product. Failure to follow the proper installation procedures could lead to death or permanent injury.
- This product is intended to be installed in pressurized pipe applications. In this event, product will be under pressure, caution should be taken to properly vent system prior to installation or removal of the unit. Failure to do so could result in equipment damage and/or serious bodily injury.

#### CAUTION

- Refer to Model Chart and Specifications for the applicable options to your unit.
- Ensure the unit is solidly grounded as stated in this bulletin.
- Depressurize and vent systems without Hot-tap valve prior to installation or removal.
- Confirm the Series IEFB wetted material is chemically compatible with process media prior to installation and use.
- Do not exceed maximum temperature and pressure specifications.
- Wear appropriate personal protective equipment during installation, removal and or service of the unit.
- Altering the product construction may adversely affect product operation and voids warranty.

### OPERATING PRINCIPLE

- Per Faraday's Law of electromagnetic induction, a voltage is induced in a conductor when the fluid passes through a magnetic field, and the induced voltage will be directly proportional to the velocity of the conductor.
- The Series IEFB Insertion Thermal Energy Meter generates pulsating magnetic fields in the probe to induce a voltage into a conductive fluid flowing through the pipe.
- Electrodes located on the probe measure the induced voltage. Electronics and firmware within the enclosure convert the voltage to velocity and flow rate while using various outputs to convey the data to connected systems (i.e. display devices, data acquisition systems, etc.).
- The IEFB energy calculations are based on flow and temperature measurements while compensating for density and heat content.

### INCLUDED WITH THE SERIES IEFB INSERTION THERMAL ENERGY METER

- Carefully unpack the shipping container of your new Series IEFB Insertion Thermal Energy Meter and remove the following items:
  - (1) Series IEFB insertion thermal energy meter
  - (2) RTDs – Temperature measuring probes (not shown)
  - (1) A-IEF-INGD installation alignment kit:
    - (1) Alignment scale with captive thumbscrews
    - (2) Alignment rods (not shown)
  - (1) 3 mm Allen wrench (not shown, located in IEFB hanging tag)
  - (2) Hot tap thermowells (model dependent)
  - (1) Thermal paste (not shown)

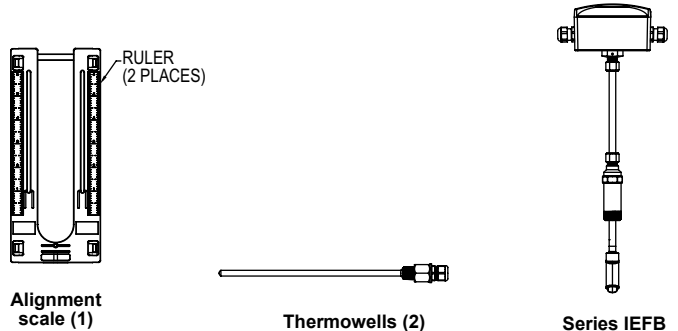

Figure 2: Included with IEFB

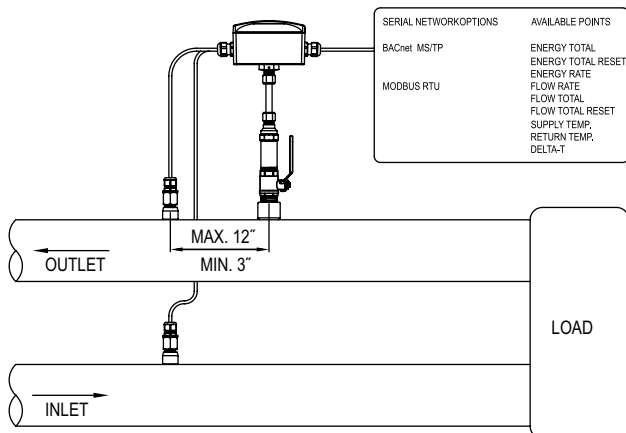

Figure 1: Typical installation

**RECOMMENDED TOOLS**

- (2) 12" (300 mm) adjustable wrenches
- (1) 12" (300 mm) pipe wrench

**SETUP**

**Selecting Installation Location**

1. Although the unit may be installed in any orientation, the ideal mounting position is on the side of the pipe (2 o'clock or 10 o'clock position)\* as this generally minimizes possible air or sediment interference with the Series IEFB. It is not recommended to mount the unit below the pipe (6 o'clock position).

**NOTICE** When installing a unit with an integral display select an installation location that allows for clear viewing of the display and earth ground.

2. Insert the IEFB in a pipe via a threaded Tee, Saddle, or welded integrally reinforced branch connection outlet fitting.

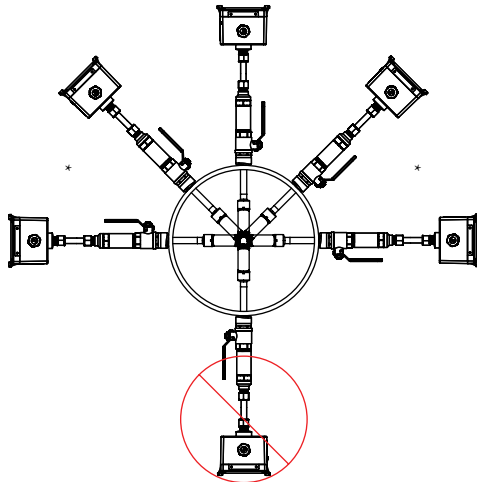
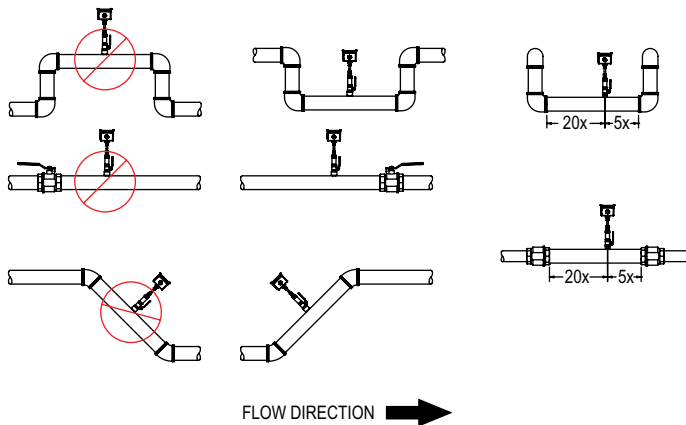

**Figure 3: Proper installation orientation**

- a. If a Hot-Tap option is required for the IEFB, use a 1-1/4" valve kit with proper mounting hardware available in Model A-IEF-VLV-BR or A-IEF-VLV-SS. A 1" (25 mm) hole in the pipe is required for proper installation.
  - b. If a Hot-Tap option is required for the RTD thermowells, use a 1" valve kit with proper mounting hardware available in Model A-IEFB-VLV-BR-1 or A-IEFB-VLV-SS-1. A 1" (25 mm) hole in the pipe is required for proper installation.
3. Select a location that will minimize flow distortion with adequate upstream and downstream pipe diameters as displayed. Ideal installation will have a minimum of 10 pipe diameters upstream relative to the instrument and a minimum distance of 5 pipe diameters downstream.

**NOT RECOMMENDED**

**RECOMMENDED**



**Figure 4: Proper installation location**

**IEFB THERMAL ENERGY METER INSTALLATION FLOWMETER INSTALLATION**

1. To prepare the meter for installation, mount the provided alignment scale to the side of the meter using the two captured thumbscrews, finger tighten only. Be sure to orient the alignment scale as shown in Figure 5 below. Actual scale setting determined in next step.

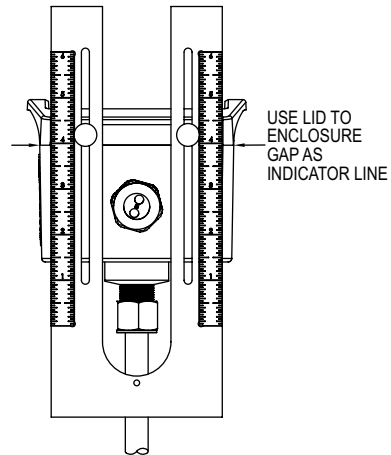

**Figure 5: Alignment scale installed on IEFB**

**For Custom Configured Models (-CC Option) only. For field configurable models, move to the next section.**

2. Use the configuration tag attached to the Series IEFB to identify the value of the alignment scale setting. Position the alignment scale such that the scale setting is lined-up with the seam of the enclosure as shown in Figure 5. Securely tighten the thumbscrews.
3. Skip to Preparing the Unit for Installation.

**Note:** Minor scale marks are in 1/20ths and take in to account total installation depth.

**For Field Configurable Models**

2. For field configuration, a display is required (-LCD option or accessory A-IEF-DSP) and needs to be powered via normal field wiring or with the AC wall adapter accessory A-IEF-PA (A-IEF-DSP and A-IEF-PA are also available in the accessory setup kit A-IEF-KIT).
  - a. When using the AC wall adapter and the cable supplied, connect the red (positive +) and black (common -) wires of the cable bundle marked "A" to the open terminals of the AC wall adapter. This will provide temporary power to the meter to complete the installation set up.
  - b. For field wiring, refer to the wiring chart tag attached to the Series IEFB to identify the terminal block pins for positive (+) and common (-) connection. If prewired, refer to wiring chart located on the tag.
  - c. Unscrew the four captured cover screws using the supplied 3 mm Allen wrench to remove and set aside enclosure cover.
  - d. If using an A-IEF-DSP or the A-IEF-KIT, insert one connector of the ribbon cable supplied in the setup kit into the connector labeled "Display" in the middle of the unit. Be sure to orient the keying feature/tab. See Figure 6 below:

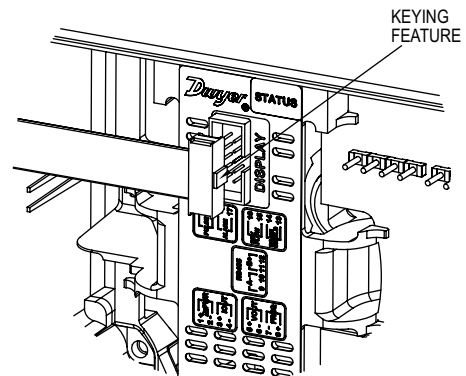

**Figure 6: Connecting the display for field configurable models**

3. Plug the other end of the cable into the bottom of A-IEF-DSP or A-IEF-KIT. Orient the keying feature/tab as shown:

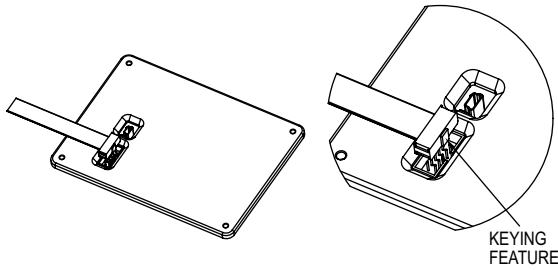

Figure 7: Keying feature

4. Apply power to the unit to turn on the display. Follow the on-screen directions for entering the necessary parameters to set up the unit. Obtain the alignment scale setting values and record them below:  
A. IEFB "Alignment Scale Value"

\_\_\_\_\_

This is the value needed for flowmeter installation.

#### Preparing the Unit for Installation

**NOTICE** Precise pipe measurements are required for high performance installation. The A-IEF-KIT includes setup display A-IEF-DSP, thickness gage UTG and measuring tape A-IEF-MSTP used to obtain these measurements. When the precise pipe measurement information is known, select Option 2, High Performance setup, within the pipe setup menu.

**NOTICE** When using measuring tape A-IEF-MSTP to measure pipe circumference, use the 100ths side to measure the circumference of the pipe (without insulation).

#### Preparing the Unit for installation (Figure 8)

1. Apply appropriate sealant to the process collet threads (5) such as sealant tape or paste as suitable for the application.
2. Install the process collet (5) in valve (6), then tighten by hand.
3. Using the hex geometry, tighten the process collet (5) with a wrench to 180 in-lbs.
4. Slowly open the valve handle (7), checking for leaks. If leaks occur around threaded connections, close the valve and tighten those connections.

**NOTICE** Use two wrenches, one to hold the valve and another wrench to turn the process collet.

**NOTICE** Do not adjust housing compression nut at top of probe shaft (3).

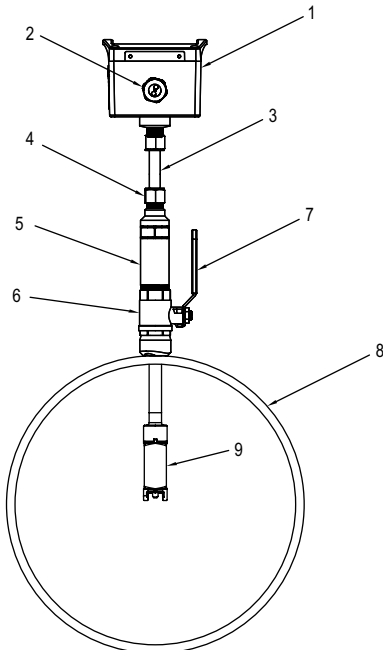

1. Enclosure
2. Cable Nut
3. Probe Shaft
4. Compression Fitting
5. Process Collet
6. Valve
7. Valve Handle
8. Pipe
9. Sensor Probe

Figure 8: Side system view

#### Sensor Alignment

A depth and flow alignment installation tool is provided to ensure proper depth insertion and flow alignment. To set the insertion depth, verify the alignment scale is set to the alignment scale value recorded previously as shown in figure 9 below. Loosen compression nut (4) to allow the shaft (3) freedom to travel up and down and rotate inside the process collet (5).

**Note:** Maintain the scale value recorded in step 4A from section "For Field Configurable Models."

#### Install Depth and Alignment Rods

1. Remove alignment rods from sides of alignment scale by sliding them out.
2. Insert the two rods into the alignment scale as shown in Figure 10.

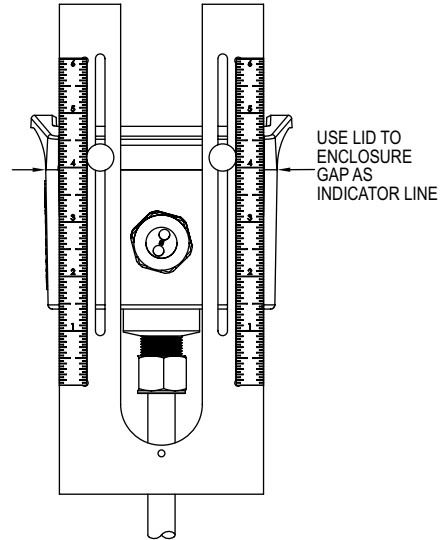

Figure 9: IEFB thermal energy meter alignment scale

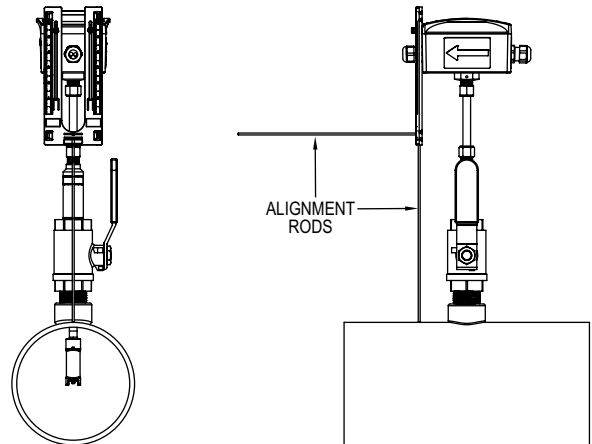

Figure 10: IEFB thermal energy meter alignment scale

3. Rotate the meter so the pipe alignment rod is parallel with the flow in the pipe.

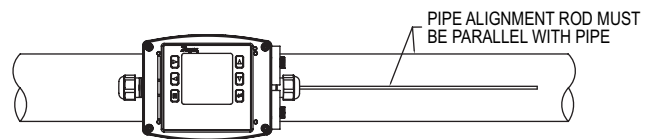

Figure 11: Flow alignment rod

4. Slide the shaft (3) down into the process collet (5) until the depth rod contacts the pipe. If pipe insulation is present, press the rod through the insulation.
  - a. Tighten the compression nut (4) to 180 in lbs. (20.3 N m)
  - b. Remove the flow alignment rod. Loosen the thumbscrews and slide the alignment tool up to remove the depth alignment rod.
  - c. Store both rods in the storage slots on the sides of the alignment scale. Tighten thumbscrews and leave alignment tool mounted on unit for storage.

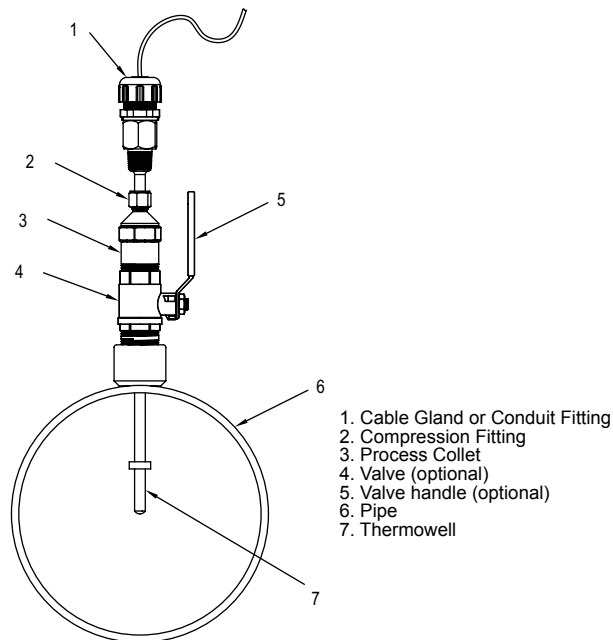

Figure 12: Hot tap installed in pipe cross section

#### Hot Tap Thermowell Sensor Depth

1. Insert the thermowell into the process collet (3) by loosening compression nut (2).  
Screw into process valve (4) open the valve by turning valve handle (5).
2. Fully insert thermowell to maximum depth.
  - a. If thermowell makes contact with pipe ID, retract 1/4" (65 mm).
3. Tighten the nut (2) to 15 ft.-lbs (20.3 N m).
4. Repeat steps 1 through 3 for insertion of the second thermowell.

**Note:** For best accuracy, insulate the portion of the thermowells that is outside the pipe.

#### RTD INSTALLATION

##### Standard Thermowells

When installing temperature sensors in a new or drained fluid system, the IEFB uses standard thermowells.

For accurate energy usage measurement, the temperature sensors in the inlet and outlet must be located in ideal positions. One thermowell will be installed in the downstream run of pipe as the IEFB (minimum of 3" (75 mm) and no more than 12" (300 mm) from the flowmeter.) The second thermowell will be placed in the return path of the measured system.

**Note:** Ensure the selected locations for the thermowells are at suitable distances given the length of the RTD cable lengths provided.

Select the appropriate standard thermowell size for the application pipe size. 4" (100 mm) and 6" (150 mm) Standard Thermowells are available. The pipe size ranges are listed below:

##### 4" (100 mm) Standard Thermowells for 1-1/2" Maximum Stack Height:

4 to 7" (100 to 175 mm) Pipe Size

##### 6" (150 mm) Standard Thermowells for 1-1/2" Maximum Stack Height:

8 to 36" (200 to 250 mm) Pipe Size

Ideal insertion depth is 3"

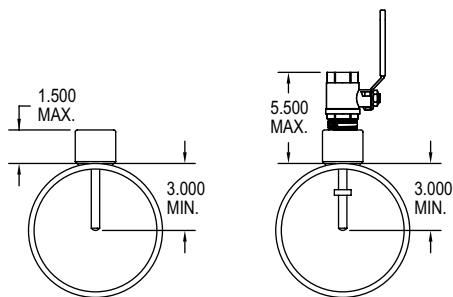

Figure 13: Stack height

## RTD INSTALLATION

The Series IEFB is provided with a matched pair of temperature sensors. These temperature sensors must be wired to the IEFB and properly installed into the accessory thermowells.

### Cable Gland (PG 16) Thermowell (refer to Figure 14 below)

1. Remove compression nut (1) by unscrewing from cable gland (2).
2. Remove insert (3) from the cable gland (2).
3. Route the RTD through compression nut (1) and cable gland (2), then into the insert (3) and washer (4).

**Note:** Ensure insert (3) is oriented correctly, as shown in Figure 14 below.

4. Apply a generous coating of provided thermal paste onto the RTD.
5. For best accuracy, firmly insert the RTD into the thermowell, ensuring the tip of the RTD touches the bottom of the thermowell.
6. Screw the cable gland (2) into the thermowell.
7. Tighten the compression nut (1) onto the cable gland (2) to 30 in/lbs.

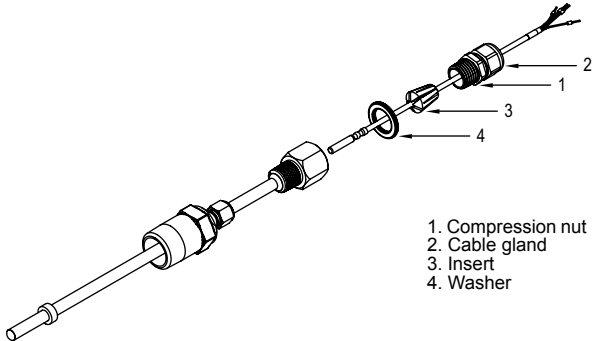

Figure 14: Thermowell assembly with PG gland

### Conduit Fitting Thermowell (refer to Figure 15 below)

1. Pull the RTD through the conduit.
2. Push the RTD through the conduit fitting. Route the RTD through compression nut (1) and conduit fitting (2), then into the insert (3) and washer (4).
3. Apply a generous coating of provided thermal paste onto the RTD.
4. Firmly insert the RTD into the thermowell ensuring the tip of the RTD touches the bottom of the thermowell.
5. Tighten the conduit fitting into the thermowell to 30 in/lbs.
6. Secure the conduit into the conduit fitting.

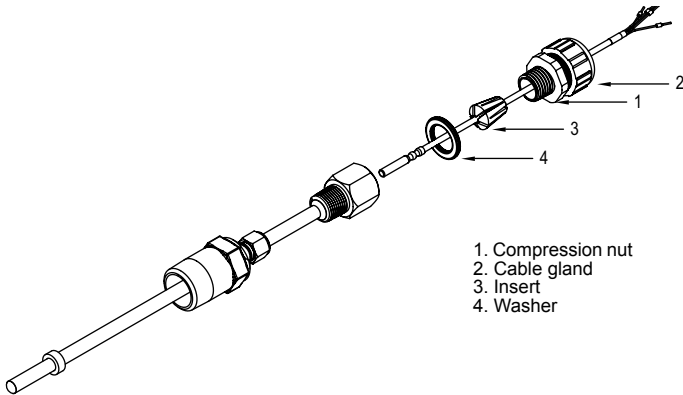

Figure 15: Thermowell assembly with CND gland

## GROUNDING

### Metallic Pipe

For proper operation, the IEFB must be earth grounded.

1. Connect a ground wire to meter housing via the ground lug on the housing collet.
2. Connect the ground wire to a known earth ground.
  - a. If the pipe is grounded, connect the ground wire to the pipe using suitable devices such as grounding clamps.

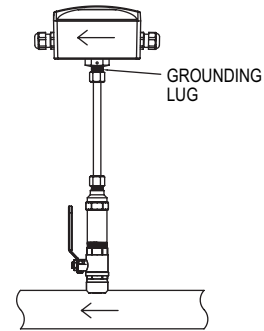

Figure 16: Metallic grounding

### Non-Metallic Pipes

1. Connect a ground wire to the meter housing per the ground lug on the housing collet.
2. Connect the ground wire to a known earth ground.
3. Ground the fluid to earth.

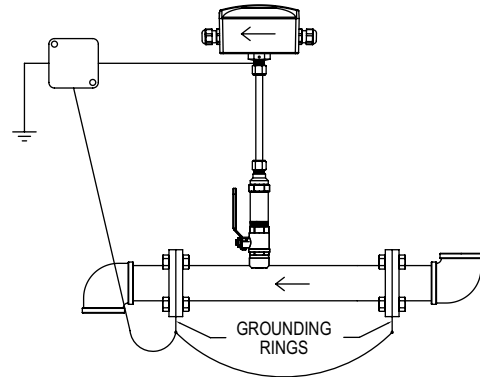

Figure 17: Non-metallic grounding

### POWER SUPPLY

1. Choose a power supply with a voltage and current rating that meets the power specifications under all operating conditions.
2. If the power supply is unregulated, make sure the output voltage remains within the required voltage range under all power line conditions.

WIRING DIAGRAM				
Cable	Terminal #	Wire Color	Description	Note
A	1	Red	Power Supply Positive	Connect to +24VDC or VAC transformer Connect to 24VDC/VAC common If used - Application Dependand If used - Application Dependand
A	2	Black	Power Supply Common	
A	13	Shield	-	
B	14	Shield	-	
External		-	Earth/Chassis Ground	-
Analog Current Output				
B	3	Brown	(+) Analog current output	4 to 20 mA process output Current output common
B	4	Blue	(-) Analog output common	
Analog Voltage Output				
B	5	Green	(+) Analog voltage output	May be configured; 0 to 10 V, 0 to 5 V, 2 to 10 V, etc. Voltage output common
B	6	White	(-) Analog output common	
Frequency Output				
B	8	Violet	(+) Frequency output	0 to 500 Hz output (@ 0/15 VDC output level) Frequency output common
B	7	Grey	(-) Analog output common	
RS-485 Communication (optional)				
B	11,12	Orange	RS-485 (+)	On board short for daisy chain connection On board short for daisy chain connection
B	9,10	Yellow	RS-485 (-)	
Reverse Flow				
A	15	Brown	Isolated solid state output N.O.	50 V AC/VDC @ 100 mA maximum 50 V AC/VDC @ 100 mA maximum
A	16	Blue	Isolated solid state output N.O.	
Alarm				
A	17	Green	Isolated solid state output N.O.	50 V AC/VDC @ 100 mA maximum 50 V AC/VDC @ 100 mA maximum
A	18	White	Isolated solid state output N.O.	
Pulse				
A	19	Orange	Isolated solid state output N.O.	50 V AC/VDC @ 100 mA maximum 50 V AC/VDC @ 100 mA maximum
A	20	Yellow	Isolated solid state output N.O.	
No Connection				
B	-	Red	Do not connect	-
B	-	Black	Do not connect	-
A	-	Violet	Do not connect	-
A	-	Grey	Do not connect	-

The Cable column identifying cable A and B is reflective of units that include factory installed cabling.

Wiring PCBA shown in Figure 18 with terminal block numbers as listed in above wiring diagram chart.

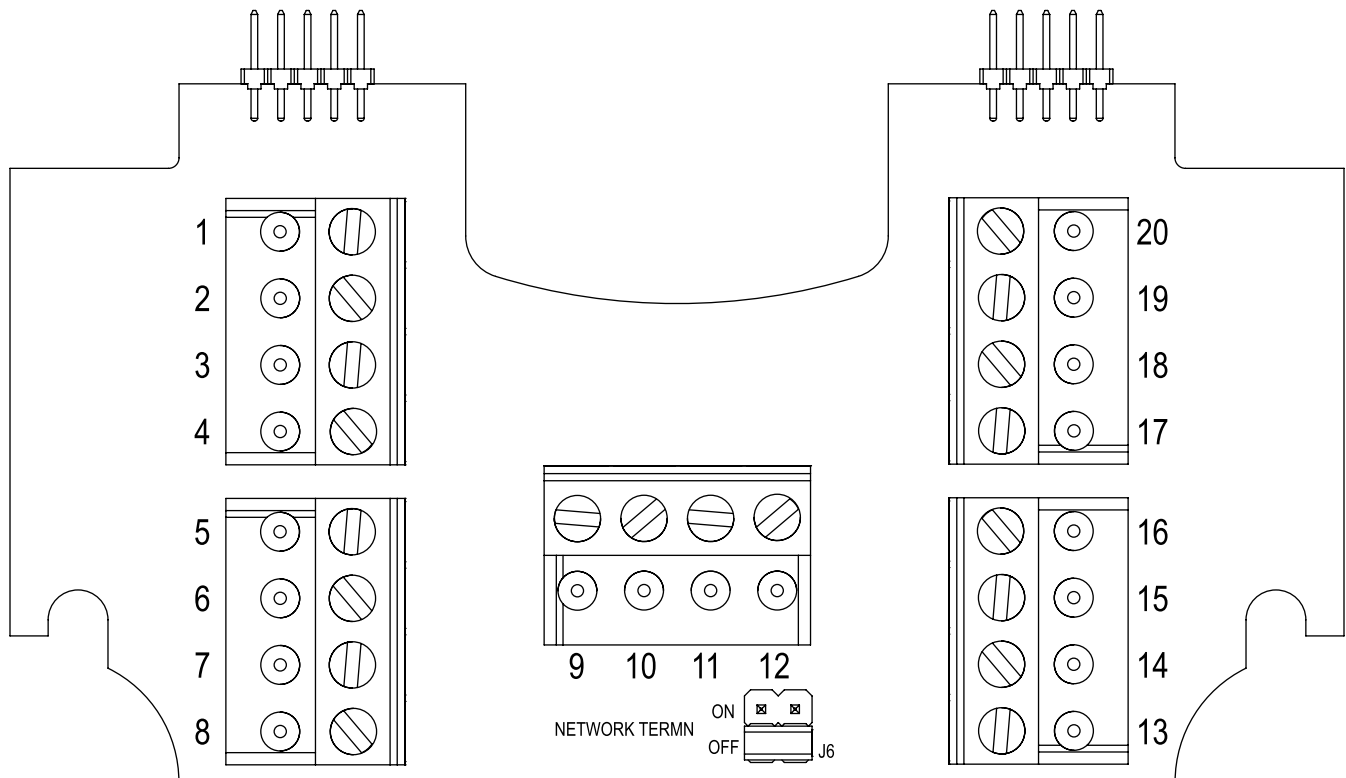

Figure 18: PCBA

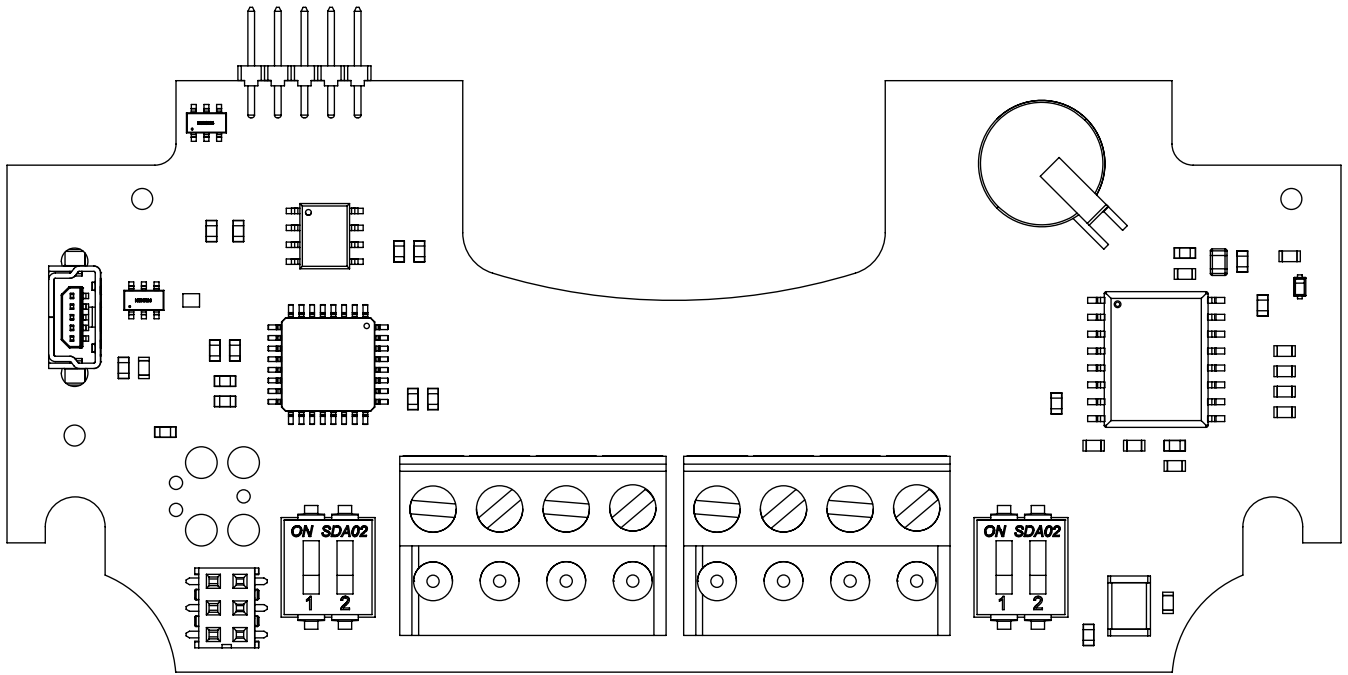

Figure 19: PCBA

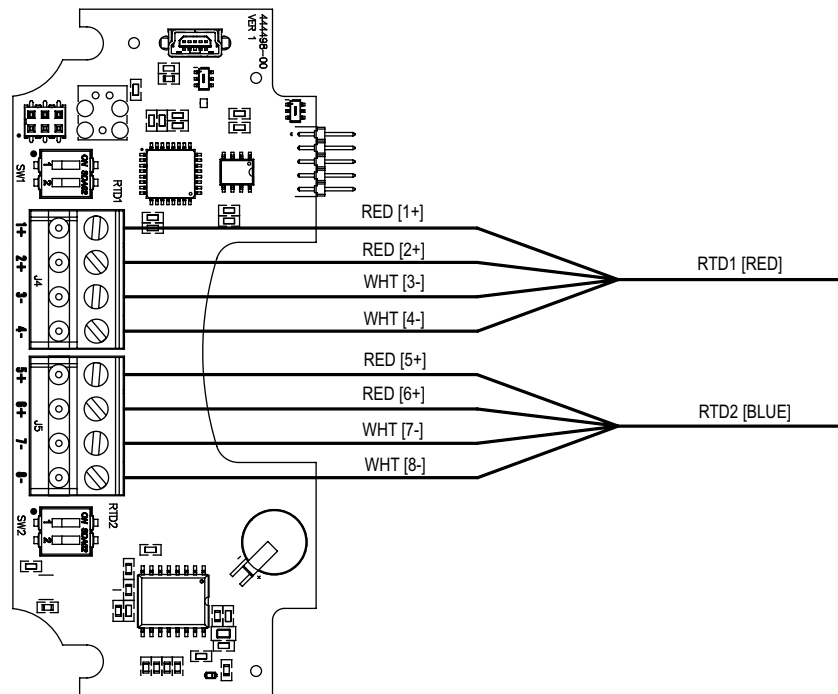

Figure 20: Wiring diagram



**IEFB SETUP**  
**IEFB FLOWMETER SETUP**

**Determining IEFB probe insertion depth for models with a display**

Use the Series IEFB insertion thermal energy meter with -LCD display option or A-IEF-DSP to calculate the probe insertion depth.

**NOTICE** Precise pipe measurements are required for a high performance installation. It is recommended to use the A-IEF-KIT which includes a setup display A-IEF-DSP, thickness gage UTG and measuring tape A-IEF-MSTP to obtain these measurements. When the precise pipe measurement information is known, select High Performance Setup under the Install Kit Menu when prompted by the display as shown below.

1. To measure the pipe circumference, remove any existing insulation at the location where the meter will be installed. Wrap the tape measure around the pipe at the selected location using the 100ths side of the tape. Record this measurement to enter later when prompted.

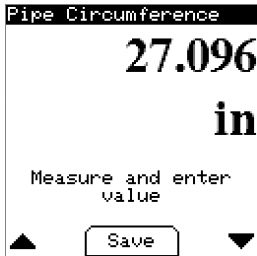

2. To measure the wall thickness of the pipe, use the thickness gage UTG. Follow the directions provided with the UTG gage and record the thickness to enter later when prompted.
3. Follow the on-screen directions for entering the circumference and wall thickness dimensions. See the Electronic Control Data Setup section of this manual for more information.

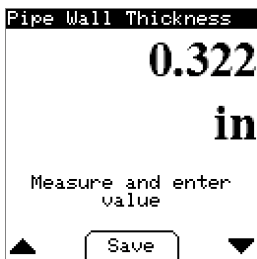

**Determining IEFB probe insertion depth for models without a display**  
 For models without a display, the following formulas allow for calculating the alignment scale value. Pipe wall thickness charts are also included on the next page.

Models IEFB-LX-X-X, IEFB-HX-X-X, IEFB-FX-X-X, IEFB- IX-X-X, IEFB-EX-X-X, IEFB-TX-X-X :  $7.1665-1/2*D$   
 Models IEFB-GX-X-X:  $7.1665-((0.1*(D-2*WT))+WT)$   
 Models IEFB-SX-X-X:  
 Pipes < 11 in (< 279 mm) diameter:  $7.1665-1/2*D$   
 Pipes > 11 in to 36 inches :  $7.1665-((0.1*(D-2*WT))+WT)$

Where D represents the pipe outer diameter and WT represents the pipe wall thickness, both in inches.

Measurement of the circumference and wall thickness can be accomplished using A-IEF-KIT, as described in the previous section, or similar method. Precise pipe measurements are required for a high performance installation.

Position the alignment scale such that the alignment scale setting is lined-up with the seam of the enclosure as shown in Figure 21. Minor scale marks are in 1/20ths. Securely finger tighten the thumbscrews.

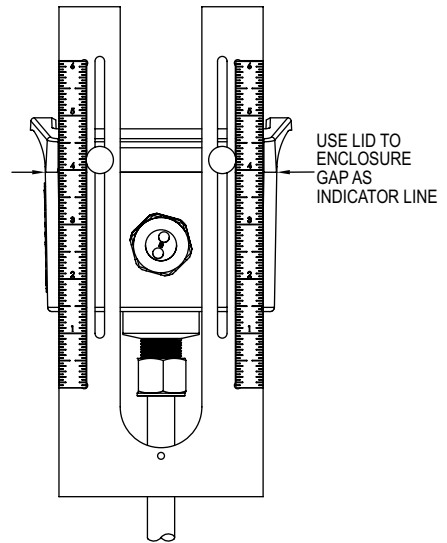

Figure 21: Alignment scale positioning

WALL THICKNESS									
Carbon Steel									
Pipe Diameter (in)	DN (mm)	SCH5 (in)	SCH5 (mm)	SCH10 (in)	SCH10 (mm)	SCH40 (in)	SCH40 (mm)	SCH80 (in)	SCH80 (mm)
4.5	114.30	0.083	2.110	0.120	3.050	0.237	6.020	0.337	8.560
5.563	141.30	0.109	2.770	0.134	3.400	0.258	6.550	0.375	9.530
6.625	168.28	0.109	2.770	0.134	3.400	0.280	7.110	0.432	10.970
8.625	219.08	0.109	2.770	0.148	3.760	0.322	8.180	0.500	12.700
10.75	273.05	0.134	3.400	0.165	4.190	0.365	9.270	0.593	15.090
12.75	323.85	0.156	3.960	0.180	4.570	0.406	10.310	0.687	17.480
14	355.60	0.156	3.960	0.250	6.350	0.437	11.130	0.750	19.050
16	406.40	0.165	4.190	0.250	6.350	0.500	12.700	0.843	21.440
18	457.20	0.165	4.190	0.250	6.350	0.562	14.270	0.937	23.830
20	508.00	0.188	4.780	0.250	6.350	0.593	15.090	1.031	26.190
24	609.60	0.218	5.540	0.250	6.350	0.688	17.480	1.218	30.960
32	813.00	0.250	6.350	0.312	7.920	0.688	17.480	1.218	30.960
36	914.40	0.250	6.350	0.312	7.920	0.750	19.050	1.218	30.960

WALL THICKNESS									
Stainless Steel									
Pipe Diameter (in)	DN (mm)	SCH5 (in)	SCH5 (mm)	SCH10 (in)	SCH10 (mm)	SCH40 (in)	SCH40 (mm)	SCH80 (in)	SCH80 (mm)
4.5	114.30	0.083	2.110	0.120	3.050	0.237	6.020	0.337	8.560
5.563	141.30	0.109	2.770	0.134	3.400	0.258	6.550	0.375	9.525
6.625	168.28	0.109	2.770	0.134	3.400	0.280	7.110	0.432	10.970
8.625	219.08	0.109	2.770	0.148	3.760	0.322	8.180	0.500	12.700
10.75	273.05	0.134	3.400	0.165	4.190	0.365	9.270	0.500	12.700
12.75	323.85	0.156	3.960	0.180	4.570	0.375	9.525	0.500	12.700
14	355.60	0.156	3.960	0.188	4.780	0.375	9.525	0.500	12.700
16	406.40	0.165	4.190	0.188	4.780	0.375	9.525	0.500	12.700
18	457.20	0.165	4.190	0.188	4.780	0.375	9.525	0.500	12.700
20	508.00	0.188	4.780	0.218	5.540	0.375	9.525	0.500	12.700
24	609.60	0.218	5.540	0.250	6.350	0.375	9.525	0.500	12.700
32	813.00	0.250	6.350	0.312	7.920	0.375	9.525	0.500	12.700
36	914.40	0.250	6.350	0.312	7.920	0.375	9.525	0.500	12.700

WALL THICKNESS							
Copper							
Pipe Diameter (in)	DN (mm)	Type K		Type L		Type M	
		in	mm	in	mm	in	mm
4.125	104.78	0.134	3.400	0.114	2.895	0.095	2.413
5.125	130.18	0.160	4.064	0.125	3.175	0.109	2.768
6.125	155.58	0.192	4.876	0.140	3.556	0.122	3.098
8.125	206.38	0.271	6.883	0.200	5.080	0.170	4.318
10.25	257.18	0.341	8.661	0.356	9.042	0.308	7.823
12.25	307.98	0.411	10.439	0.411	10.439	0.356	9.042
14	355.60	0.471	11.963	0.459	11.658	0.398	10.109
16	406.40	0.471	11.963	0.459	11.658	0.398	10.109
18	457.20	0.541	13.741	0.513	13.030	0.445	11.303
20	508.00	0.610	15.494	0.568	14.427	0.493	12.522
24	609.60	0.680	17.272	0.623	15.824	0.541	13.741
32	813.00	0.818	20.777	0.732	18.593	0.636	16.154
36	914.40	1.096	27.838	0.950	24.130	0.826	20.980

WALL THICKNESS					
PVC					
Pipe Diameter (in)	DN (mm)	SCH40		SCH80	
		in	mm	in	mm
4.5	114.00	0.237	6.020	0.337	8.560
5.563	141.00	0.258	6.550	0.375	9.520
6.625	168.00	0.280	7.110	0.432	11.000
8.625	219.00	0.322	8.180	0.500	12.700
10.75	273.00	0.365	9.270	0.593	15.100
12.75	324.00	0.406	10.300	0.687	17.400
14	356.00	0.437	11.100	0.750	19.000
16	406.00	0.500	12.700	0.843	21.400
18	457.20	0.562	14.274	0.937	23.800
20	508.00	0.593	15.062	1.031	26.187
24	609.60	0.687	17.450	1.218	30.937
32	813.00	0.874	22.200	1.572	39.929
36	914.40	0.968	24.587	1.754	44.552

WALL THICKNESS									
Carbon Steel									
Pipe Diameter (in)	DN (mm)	SCH5 (in)	SCH5 (mm)	SCH10 (in)	SCH10 (mm)	SCH40 (in)	SCH40 (mm)	SCH80 (in)	SCH80 (mm)
4.5	114.30	0.083	2.110	0.120	3.050	0.237	6.020	0.337	8.560
5.563	141.30	0.109	2.770	0.134	3.400	0.258	6.550	0.375	9.530
6.625	168.28	0.109	2.770	0.134	3.400	0.280	7.110	0.432	10.970
8.625	219.08	0.109	2.770	0.148	3.760	0.322	8.180	0.500	12.700
10.75	273.05	0.134	3.400	0.165	4.190	0.365	9.270	0.593	15.090
12.75	323.85	0.156	3.960	0.180	4.570	0.406	10.310	0.687	17.480
14	355.60	0.156	3.960	0.250	6.350	0.437	11.130	0.750	19.050
16	406.40	0.165	4.190	0.250	6.350	0.500	12.700	0.843	21.440
18	457.20	0.165	4.190	0.250	6.350	0.562	14.270	0.937	23.830
20	508.00	0.188	4.780	0.250	6.350	0.593	15.090	1.031	26.190
24	609.60	0.218	5.540	0.250	6.350	0.688	17.480	1.218	30.960
32	813.00	0.250	6.350	0.312	7.920	0.688	17.480	1.218	30.960
36	914.40	0.250	6.350	0.312	7.920	0.750	19.050	1.218	30.960

WALL THICKNESS									
Stainless Steel									
Pipe Diameter (in)	DN (mm)	SCH5 (in)	SCH5 (mm)	SCH10 (in)	SCH10 (mm)	SCH40 (in)	SCH40 (mm)	SCH80 (in)	SCH80 (mm)
4.5	114.30	0.083	2.110	0.120	3.050	0.237	6.020	0.337	8.560
5.563	141.30	0.109	2.770	0.134	3.400	0.258	6.550	0.375	9.525
6.625	168.28	0.109	2.770	0.134	3.400	0.280	7.110	0.432	10.970
8.625	219.08	0.109	2.770	0.148	3.760	0.322	8.180	0.500	12.700
10.75	273.05	0.134	3.400	0.165	4.190	0.365	9.270	0.500	12.700
12.75	323.85	0.156	3.960	0.180	4.570	0.375	9.525	0.500	12.700
14	355.60	0.156	3.960	0.188	4.780	0.375	9.525	0.500	12.700
16	406.40	0.165	4.190	0.188	4.780	0.375	9.525	0.500	12.700
18	457.20	0.165	4.190	0.188	4.780	0.375	9.525	0.500	12.700
20	508.00	0.188	4.780	0.218	5.540	0.375	9.525	0.500	12.700
24	609.60	0.218	5.540	0.250	6.350	0.375	9.525	0.500	12.700
32	813.00	0.250	6.350	0.312	7.920	0.375	9.525	0.500	12.700
36	914.40	0.250	6.350	0.312	7.920	0.375	9.525	0.500	12.700

WALL THICKNESS							
Copper							
Pipe Diameter (in)	DN (mm)	Type K		Type L		Type M	
		in	mm	in	mm	in	mm
4.125	104.78	0.134	3.400	0.114	2.895	0.095	2.413
5.125	130.18	0.160	4.064	0.125	3.175	0.109	2.768
6.125	155.58	0.192	4.876	0.140	3.556	0.122	3.098
8.125	206.38	0.271	6.883	0.200	5.080	0.170	4.318
10.25	257.18	0.341	8.661	0.356	9.042	0.308	7.823
12.25	307.98	0.411	10.439	0.411	10.439	0.356	9.042
14	355.60	0.471	11.963	0.459	11.658	0.398	10.109
16	406.40	0.471	11.963	0.459	11.658	0.398	10.109
18	457.20	0.541	13.741	0.513	13.030	0.445	11.303
20	508.00	0.610	15.494	0.568	14.427	0.493	12.522
24	609.60	0.680	17.272	0.623	15.824	0.541	13.741
32	813.00	0.818	20.777	0.732	18.593	0.636	16.154
36	914.40	1.096	27.838	0.950	24.130	0.826	20.980

WALL THICKNESS					
PVC					
Pipe Diameter (in)	DN (mm)	SCH40		SCH80	
		in	mm	in	mm
4.5	114.00	0.237	6.020	0.337	8.560
5.563	141.00	0.258	6.550	0.375	9.520
6.625	168.00	0.280	7.110	0.432	11.000
8.625	219.00	0.322	8.180	0.500	12.700
10.75	273.00	0.365	9.270	0.593	15.100
12.75	324.00	0.406	10.300	0.687	17.400
14	356.00	0.437	11.100	0.750	19.000
16	406.00	0.500	12.700	0.843	21.400
18	457.20	0.562	14.274	0.937	23.800
20	508.00	0.593	15.062	1.031	26.187
24	609.60	0.687	17.450	1.218	30.937
32	813.00	0.874	22.200	1.572	39.929
36	914.40	0.968	24.587	1.754	44.552

### Printing out configuration values

After installation is complete, a table of configuration values can be printed to insert into one of the hanging plastic envelopes for future reference. The housing cover/display needs to be removed to access to the display port, which is necessary to retrieve the table of configuration values.

1. Unscrew the four captured cover screws using the supplied 3 mm Allen wrench and remove the enclosure cover. Leave the display cable connected to the main unit.
2. Insert a mini-USB cable (not included) into the USB connector on the bottom side of the display PCB.
3. Connect the other end of the cable into a standard USB port in a laptop.
4. The Series IEFB insertion thermal energy meter will appear as a standard USB drive on the laptop.
5. The file name with the configuration values is in the format of: serial number.txt. The serial number can be found on the product label on the side of the meter.
6. Print out the configuration values and insert into one of the hanging plastic envelopes for future reference
7. Re-attach the housing cover/display by tightening the four 3 mm screws.

CONFIGURATION DATA PRINT OUT EXAMPLE
<b>[Flow Meter Information]</b>
MeterTag=Series IEFB SerialNumber=018M8Y ModelNumber=IEFB-HN-10-LCD-COM DateCode=20190319
<b>[Energy Meter Information]</b>
SerialNumber=TestCal4 DateCode=20190101
<b>[Setup Information]</b>
CalibratedBy= Date= Units=English VelocityUnit=ft/s FlowUnit=ft <sup>3</sup> /s MassFlowUnit=lbm/h VolumeUnit=gal TemperatureUnit=°F PowerUnit=kW EnergyUnit=kWh
<b>[Pipe Configuration]</b>
LiquidType=Water PipeMaterial=Carbon Steel PipeDiameter=8 in PipeWallThickness=Schedule 40 AlignmentScaleValue=2.85 ThermowellDepth=Maximum Depth
<b>[Energy Meter Setup]</b>
FlowMeterLocation=Inlet RTDLocationMapping=1=Inlet, 2=Outlet HeatingChangeoverTemperature=77 ProcessPressure=232.060 PSI
<b>[Analog Output]</b>
AnalogOutputType=Current 4-20mA AnalogOutputVariable=Velocity ft/s AnalogOutputHigh=20.00 AnalogOutputLow=0.00
<b>[Pulse/Freq. Output Setup]</b>
Pulse/Freq. Output=Pulse PulseOutputVariable=Total Flow PulseOutput=7 gal/pulse PulseWidth=50 ms
<b>[Alarm Output Setup]</b>
AlarmOutput=Velocity Alarm VelocityAlarmType=Low Limit VelocityAlarmTrigger=0.10 ft/s VelocityAlarmHysteresis=0.05 ft/s
<b>[Communication]</b>
CommunicationProtocol=Modbus NetworkAddress=127 BaudRate=115200 SerialParity=Even SerialStopbits=1

### Removing Series IEFB Insertion Thermal Energy Meter

1. To remove the meter from an installation without a valve, depressurize the pipe and skip to step 4. If installed with a valve loosen compression fitting (4) and withdraw the meter shaft fully through the valve until it stops.

**WARNING** Contents under high pressure.

2. Tighten compression fitting (4) snug.
3. Close valve (6) via valve handle (7).
4. Remove meter by unscrewing process collet (5) from valve (6).

**CAUTION** Be sure to support the housing end of the meter to prevent it from flipping while unscrewing process collet (5) as damage may occur to the probe fins.

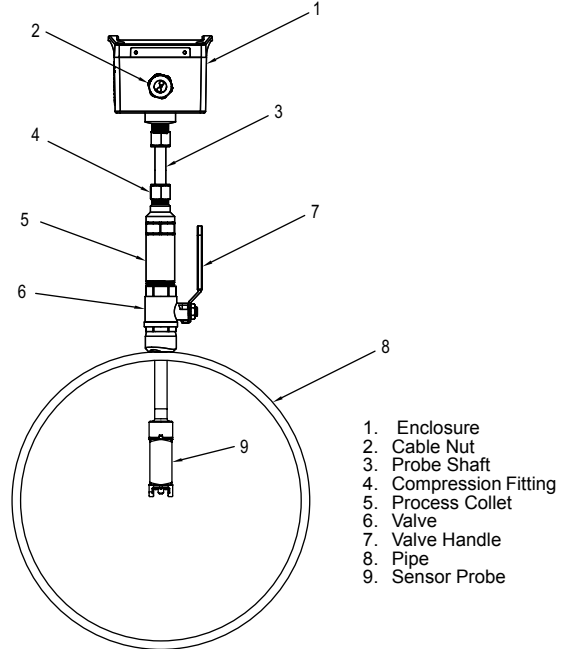

Figure 22: IEFB Side System View

### Removing Thermowells

1. To remove the thermowell from an installation without a valve, depressurize the pipe and skip to step 4. If installed with a valve, loosen compression fitting (2) and withdraw the thermowell shaft fully through the valve until it stops.

**WARNING** Contents under high pressure.

2. Tighten compression fitting (2) snug.
3. Close valve (4) via valve handle (5).
4. Remove thermowell by unscrewing process collet (3) from valve (4).

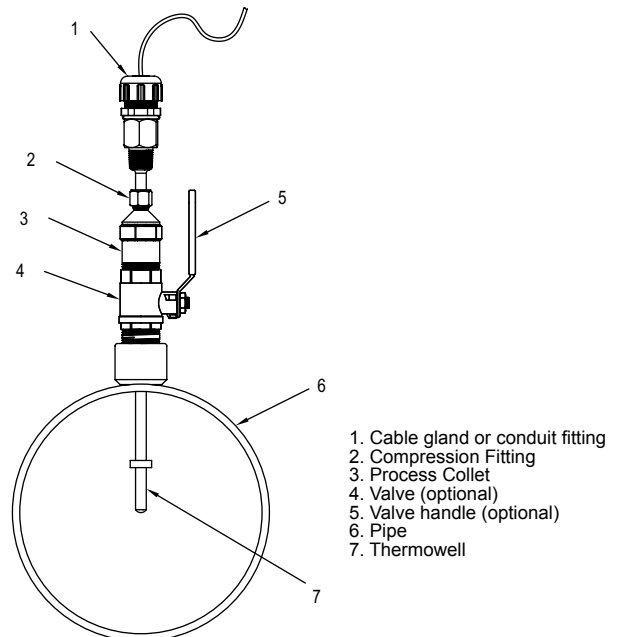

Figure 23: Hot tap thermowell installed in pipe cross section

**Network Termination Jumper**

On the terminal block PCBA there is a jumper, J1 (see Figure 24), that enables or disables a network termination resistor as defined below:

When the network jumper is in the ON position there is a 120 ohm termination resistor in place. When the network jumper is in the OFF position there is no termination resistor in place.

Default: OFF

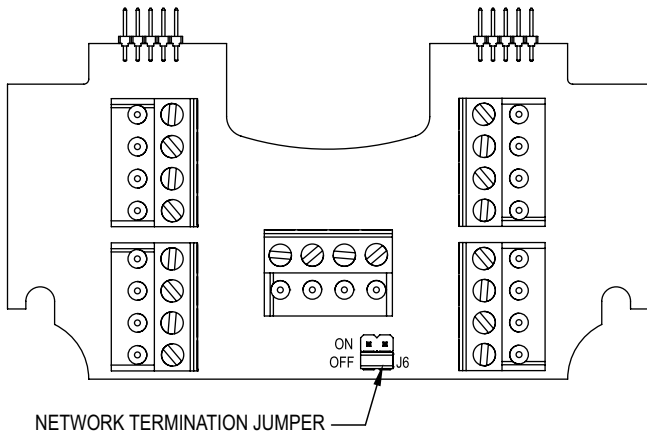

**Figure 24: Network termination jumper**

**IEFB: Communication Overview**

The IEFB supports BACnet MS/TP and Modbus® RTU over 2-wire RS485. Selection of protocol and configuration of serial parameters require the use of the display.

**BACNET  
BACnet Object Overview  
Supported BACnet Objects**

Object Type	Dynamically Creatable	Dynamically Deletable	Object Identifier	Object Name
Device	No	No	607XXX	"Series IEF 607xxx" or "Series IEFB 607xxx"
Analog Input	No	No	AI1 AI2 AI3	Velocity Inlet Temperature Outlet Temperature
Analog Value	No	No	AV1 AV2 AV3 AV4 AV5 AV6 AV7 AV8 AV9 AV10 AV11 AV12 AV13 AV14 AV15 AV16 AV17	Volume Flow Mass Flow Total Flow Power Total Energy Heat Energy Cooling Energy Differential Temperature YTD Max Power YTD Min Power MTD Max Power MTD Min Power Inlet YTD Average Temperature Outlet YTD Average Temperature Heat Changeover Temperature Process Pressure Ethylene Glycol Concentration
Binary Value	No	No	BV1 BV2 BV3 BV4	Reverse Flow Empty Pipe Reset Total Flow Reset Energy Statistics
Bit String Value	No	No	BSV1 BSV2	Flow Meter Status Flags Energy Meter Status Flags
Date Value	No	No	DV1 DV2 DV3 DV4	YTD Max Power Date YTD Min Power Date MTD Max Power Date MTD Min Power Date
Multi-State Value	No	No	MSV1 MSV2	Velocity Probe Location RTD Locations
Positive Integer Value	No	No	PIV1	Energy Hour Counter

**BACnet Objects: Device Object**

Property	Default Value	Property Data Type	Access
Object Identifier	607xxx	BACnetObjectIdentifier	Read/Write
Object Name	"Series IEF 607xxx" "Series IEFB 607xxx"	CharacterString(40)	Read/Write
Object Type	DEVICE(8)	BACnetObjectType	Read
System Status	Property List	BACnetDeviceStatus	Read
Vendor Name	"Dwyer Instruments, Inc."	CharacterString	Read
Vendor Identifier	607	Unsigned	Read
Model Name	"IEF-??-??-COM"	CharacterString	Read
Firmware Revision	"?.?"	CharacterString	Read
Application Software Version	"?.?.?"	CharacterString	Read
Location		CharacterString(32)	Read/Write
Description		CharacterString(32)	Read/Write
Protocol Version	1	Unsigned	Read
Protocol Revision	14	Unsigned	Read
Protocol Services Supported	See PICS	BACnetServicesSupported	Read
Protocol Object Types Supported	See Table Above	BACnetObjectTypesSupported	Read
Object List	See Table Above	BACnetArray	Read
Active COV Subscriptions		List of BACnetCOVSubscription	Read
Maximum APDU Length Accepted	480	Unsigned	Read
Segmentation Supported	NO_SEGMENTATION (3)	BACnetSegmentation	Read
Local Time		Time	Read
Local Date		Date	Read
UTC Offset	0	Integer	Read/Write
Daylight Savings Status	False	Boolean	Read/Write
APDU Timeout	6000	Unsigned	Read/Write
Number of APDU Retries	3	Unsigned	Read/Write
Max Master	127	Unsigned	Read/Write
Max Info Frames	1	Unsigned	Read
Device Address Binding	Empty	BACnetAddressBinding	Read
Database Revision	1	Unsigned	Read
Property List		BACnetARRAY[N] of BACnetPropertyIdentifier	
Serial Number	"xxxxxxx"	CharacterString	Read
Property List		BACnetARRAY[N] of BACnetPropertyIdentifier	Read

The default object identifier is 607xxx, where xxx is replaced by the MS/TP MAC address set in the Network Address menu. The object identifier value will change as the MS/TP MAC address changes. However, if a specific object identifier is written via BACnet, then that value is stored and changes to the MS/TP MAC address will no longer affect the object identifier.

Similarly, the default object name includes 607xxx. The object name will reflect the current object identifier. If a specific object name is written via BACnet, then that value is stored and changes to the object identifier will no longer affect the object name.

APDU Timeout values are rounded to the nearest second (1000ms). Values less than 500 will be rounded to 0 and Number of APDU Retries will be set to 0.

#### Analog Input – Velocity

Property	Default Value	Property Data Type	Access
Object Identifier	AI1	BACnetObjectIdentifier	Read
Object Name	"Velocity"	CharacterString	Read
Object Type	ANALOG_INPUT (0)	BACnetObjectType	Read
Present Value	Current reading	Real	Read
Status Flags	0	BACnetStatusFlags	Read
Event State	Normal (0)	BACnetEventState	Read
Reliability	NO_FAULT_DETECTED (0)	BACnetReliability	Read
Out of Service	FALSE (0)	Boolean	Read/Write
Units	Feet-per-second (76)	BACnetEngineeringUnits	Read/Write
COV Increment	0.5	Real	Read/Write
Property List		BACnetARRAY[N] of BACnetPropertyIdentifier	Read

#### COV Increment Value

Default Value	Minimum Value	Minimum Value	Increment
0.5 ft/s	0.1 ft/s	10.0 ft/s	0.1 ft/s

Supported Units:

Feet-per-second (76), Feet-per-minute (77), Meters-per-second (74), Meters-per-minute (163), Meters-per-hour (164), Feet-per-hour (512)\*, Feet-per-day (513)\*, Meters-per-day (514)\*

\*Non-Standard BACnet unit

#### Analog Input – Inlet Temperature

Property	Default Value	Property Data Type	Access
Object Identifier	AI2	BACnetObjectIdentifier	Read
Object Name	"Inlet Temperature"	CharacterString	Read
Object Type	ANALOG_INPUT (0)	BACnetObjectType	Read
Present Value	Current reading	Real	Read
Status Flags	0	BACnetStatusFlags	Read
Event State	Normal (0)	BACnetEventState	Read
Reliability	NO_FAULT_DETECTED (0)	BACnetReliability	Read
Out of Service	FALSE (0)	Boolean	Read/Write
Units	Degrees-Celsius (62)	BACnetEngineeringUnits	Read/Write
COV Increment	1.0	Real	Read/Write
Property List		BACnetARRAY[N] of BACnetPropertyIdentifier	Read

#### COV Increment Value

Default Value	Minimum Value	Minimum Value	Increment
1.0°C	0.1°C	10.0°C	0.1°C

Supported Units:

Degrees-Celsius (62), Degrees-Kelvin (63), Degrees-Fahrenheit (64), Degrees-Rankine (523)\*

\*Non-Standard BACnet unit

### Analog Input – Outlet Temperature

Property	Default Value	Property Data Type	Access
Object Identifier	AI3	BACnetObjectIdentifier	Read
Object Name	"Outlet Temperature"	CharacterString	Read
Object Type	ANALOG_INPUT (0)	BACnetObjectType	Read
Present Value	Current reading	Real	Read
Status Flags	0	BACnetStatusFlags	Read
Event State	Normal (0)	BACnetEventState	Read
Reliability	NO_FAULT_DETECTED (0)	BACnetReliability	Read
Out of Service	FALSE (0)	Boolean	Read/Write
Units	Degrees-Celsius (62)	BACnetEngineeringUnits	Read/Write
COV Increment	1.0	Real	Read/Write
Property List		BACnetARRAY[N] of BACnetPropertyIdentifier	Read

#### COV Increment Value

Default Value	Minimum Value	Minimum Value	Increment
1.0°C	0.1°C	10.0°C	0.1°C

Supported Units:  
 Degrees-Celsius (62), Degrees-Kelvin (63), Degrees-Fahrenheit (64), Degrees-Rankine (523)\*

\*Non-Standard BACnet unit

### Analog Value – Volume Flow

Property	Default Value	Property Data Type	Access
Object Identifier	AV1	BACnetObjectIdentifier	Read
Object Name	"Volume Flow"	CharacterString	Read
Object Type	ANALOG_VALUE (1)	BACnetObjectType	Read
Present Value	Current reading	Real	Read
Status Flags	0	BACnetStatusFlags	Read
Event State	Normal (0)	BACnetEventState	Read
Reliability	NO_FAULT_DETECTED (0)	BACnetReliability	Read
Out of Service	FALSE (0)	Boolean	Read/Write
Units	Cubic-feet-per-second (142)	BACnetEngineeringUnits	Read/Write
COV Increment	1.0	Real	Read/Write
Property List		BACnetARRAY[N] of BACnetPropertyIdentifier	Read

#### COV Increment Value

Default Value	Minimum Value	Minimum Value	Increment
1.0 ft <sup>3</sup> /s	0.133 ft <sup>3</sup> /s	13.3681 ft <sup>3</sup> /s	0.1 ft <sup>3</sup> /s

Supported Units:  
 Cubic-feet-per-second (142), Cubic-feet-per-minute (84), Cubic-feet-per-hour (191), Cubic-feet-per-day (248), US-gallons-per-minute (89), US-gallons-per-hour (192), Liters-per-second (87), Liters-per-minute (88), Liters-per-hour (136), Cubic-meters-per-second (85), Cubic-meters-per-minute (165), Cubic-meters-per-hour (135), US-gallons-per-second (515)\*, US-gallons-per-day (516)\*, Liters-per-day (517)\*, Cubic-meters-per-day (518)\*

\*Non-Standard BACnet unit

### Analog Value – Mass Flow

Property	Default Value	Property Data Type	Access
Object Identifier	AV2	BACnetObjectIdentifier	Read
Object Name	"Mass Flow"	CharacterString	Read
Object Type	ANALOG_VALUE (2)	BACnetObjectType	Read
Present Value	Current reading	Real	Read
Status Flags	0	BACnetStatusFlags	Read
Event State	Normal (0)	BACnetEventState	Read
Reliability	NO_FAULT_DETECTED (0)	BACnetReliability	Read
Out of Service	FALSE (0)	Boolean	Read/Write
Units	Pounds-mass-per-second(119)	BACnetEngineeringUnits	Read/Write
COV Increment	10.0	Real	Read/Write
Property List		BACnetARRAY[N] of BACnetPropertyIdentifier	Read

#### COV Increment Value

Default Value	Minimum Value	Minimum Value	Increment
10.0 lbm/s	10.0 lbm/s	100.0 lbm/s	0.1 lbm/s

Supported Units:  
 Kilograms-per-second (42), Kilograms-per-minute (43), Kilograms-per-hour (44), Kilograms-per-day (526)\*, Pounds-mass-per-second (119), Pounds-mass-per-minute (45), Pounds-mass-per-hour (46), Pounds-mass-per-day (47812)

\*Non-Standard BACnet unit



**Analog Value – Total Flow**

Property	Default Value	Property Data Type	Access
Object Identifier	AV3	BACnetObjectIdentifier	Read
Object Name	"Total Flow"	CharacterString	Read
Object Type	ANALOG_VALUE (2)	BACnetObjectType	Read
Present Value	Current reading	Real	Read
Status Flags	0	BACnetStatusFlags	Read
Event State	Normal (0)	BACnetEventState	Read
Reliability	NO_FAULT_DETECTED (0)	BACnetReliability	Read
Out of Service	FALSE (0)	Boolean	Read/Write
Units	US-gallons (82)	BACnetEngineeringUnits	Read/Write
COV Increment	7.48	Real	Read/Write
Property List		BACnetARRAY[N] of BACnetPropertyIdentifier	Read

**COV Increment Value**

Default Value	Minimum Value	Minimum Value	Increment
7.48 gal	1.0 gal	100.0 gal	0.1gal

Supported Units:  
Cubic-feet (79), US-gallons (83), Liters (82), Cubic-meters (80)

**Analog Value – Power**

Property	Default Value	Property Data Type	Access
Object Identifier	AV4	BACnetObjectIdentifier	Read
Object Name	"Power"	CharacterString	Read
Object Type	ANALOG_VALUE (2)	BACnetObjectType	Read
Present Value	Current reading	Real	Read
Status Flags	0	BACnetStatusFlags	Read
Event State	Normal (0)	BACnetEventState	Read
Reliability	NO_FAULT_DETECTED (0)	BACnetReliability	Read
Out of Service	FALSE (0)	Boolean	Read/Write
Units	Kilowatts (48)	BACnetEngineeringUnits	Read/Write
COV Increment	1.0	Real	Read/Write
Property List		BACnetARRAY[N] of BACnetPropertyIdentifier	Read

**COV Increment Value**

Default Value	Minimum Value	Minimum Value	Increment
1.0 kW	0.1 kW	1000 kW	0.1 kW

Supported Units:  
Watts (47), Kilowatts (48), Megawatts (49), Joule-per-hour (247), Kilojoule-per-hour (520)\*, gigajoule-per-hour (521)\*, Btus-per-hour (50), Kilo-btus-per-hour (157), Tons-refrigeration (52)  
\*Non-Standard BACnet unit

**Analog Value – Total Energy**

Property	Default Value	Property Data Type	Access
Object Identifier	AV5	BACnetObjectIdentifier	Read
Object Name	"Total Energy"	CharacterString	Read
Object Type	ANALOG_VALUE (2)	BACnetObjectType	Read
Present Value	Current reading	Real	Read
Status Flags	0	BACnetStatusFlags	Read
Event State	Normal (0)	BACnetEventState	Read
Reliability	NO_FAULT_DETECTED (0)	BACnetReliability	Read
Out of Service	FALSE (0)	Boolean	Read/Write
Units	Kilojoule (17)	BACnetEngineeringUnits	Read/Write
COV Increment	1.0	Real	Read/Write
Property List		BACnetARRAY[N] of BACnetPropertyIdentifier	Read

**COV Increment Value**

Default Value	Minimum Value	Minimum Value	Increment
1.0 kJ	1.0 kJ	10000 kJ	1.0 kJ

Supported Units:  
Kilojoule (17), Megajoule (126), Gigajoule (522)\*, Btus (20), Kilo-btus (147), Watt-hours (18), Kilowatt-hours (19), Megawatt-hours (146), Ton-hours (22)  
\*Non-Standard BACnet unit

### Analog Value – Heat Energy

Property	Default Value	Property Data Type	Access
Object Identifier	AV6	BACnetObjectIdentifier	Read
Object Name	"Heat Energy"	CharacterString	Read
Object Type	ANALOG_VALUE (2)	BACnetObjectType	Read
Present Value	Current reading	Real	Read
Status Flags	0	BACnetStatusFlags	Read
Event State	Normal (0)	BACnetEventState	Read
Reliability	NO_FAULT_DETECTED (0)	BACnetReliability	Read
Out of Service	FALSE (0)	Boolean	Read/Write
Units	Kilojoule (17)	BACnetEngineeringUnits	Read/Write
COV Increment	1.0	Real	Read/Write
Property List		BACnetARRAY[N] of BACnetPropertyIdentifier	Read

### COV Increment Value

Default Value	Minimum Value	Minimum Value	Increment
1.0 kJ	1.0 kJ	10000 kJ	1.0 kJ

Supported Units:

Kilojoule (17), Megajoule (126), Gigajoule (522)\*, Btus (20), Kilo-btus (147), Watt-hours (18), Kilowatt-hours (19), Megawatt-hours (146), Ton-hours (22)

\*Non-Standard BACnet unit

### Analog Value – Cooling Energy

Property	Default Value	Property Data Type	Access
Object Identifier	AV7	BACnetObjectIdentifier	Read
Object Name	"Cooling Energy"	CharacterString	Read
Object Type	ANALOG_VALUE (2)	BACnetObjectType	Read
Present Value	Current reading	Real	Read
Status Flags	0	BACnetStatusFlags	Read
Event State	Normal (0)	BACnetEventState	Read
Reliability	NO_FAULT_DETECTED (0)	BACnetReliability	Read
Out of Service	FALSE (0)	Boolean	Read/Write
Units	Kilojoule (17)	BACnetEngineeringUnits	Read/Write
COV Increment	1.0	Real	Read/Write
Property List		BACnetARRAY[N] of BACnetPropertyIdentifier	Read

### COV Increment Value

Default Value	Minimum Value	Minimum Value	Increment
1.0 kJ	1.0 kJ	10000 kJ	1.0 kJ

Supported Units:

Kilojoule (17), Megajoule (126), Gigajoule (522)\*, Btus (20), Kilo-btus (147), Watt-hours (18), Kilowatt-hours (19), Megawatt-hours (146), Ton-hours (22)

\*Non-Standard BACnet unit

### Analog Value – Cooling Energy

Property	Default Value	Property Data Type	Access
Object Identifier	AV7	BACnetObjectIdentifier	Read
Object Name	"Cooling Energy"	CharacterString	Read
Object Type	ANALOG_VALUE (2)	BACnetObjectType	Read
Present Value	Current reading	Real	Read
Status Flags	0	BACnetStatusFlags	Read
Event State	Normal (0)	BACnetEventState	Read
Reliability	NO_FAULT_DETECTED (0)	BACnetReliability	Read
Out of Service	FALSE (0)	Boolean	Read/Write
Units	Kilojoule (17)	BACnetEngineeringUnits	Read/Write
COV Increment	1.0	Real	Read/Write
Property List		BACnetARRAY[N] of BACnetPropertyIdentifier	Read

### COV Increment Value

Default Value	Minimum Value	Minimum Value	Increment
1.0°C	0.1°C	10.0°C	0.1°C

Supported Units:

Degrees-Celsius (62), Degrees-Kelvin (63), Degrees-Fahrenheit (64), Degrees-Rankine (523)\*

\*Non-Standard BACnet unit

#### Analog Value – YTD Max Power

Property	Default Value	Property Data Type	Access
Object Identifier	AV9	BACnetObjectIdentifier	Read
Object Name	"YTD Max Power"	CharacterString	Read
Object Type	ANALOG_VALUE (2)	BACnetObjectType	Read
Present Value	Current reading	Real	Read
Status Flags	0	BACnetStatusFlags	Read
Event State	Normal (0)	BACnetEventState	Read
Reliability	NO_FAULT_DETECTED (0)	BACnetReliability	Read
Out of Service	FALSE (0)	Boolean	Read/Write
Units	Kilojoule (17)	BACnetEngineeringUnits	Read/Write
Property List		BACnetARRAY[N] of BACnetPropertyIdentifier	Read

Supported Units:

Kilojoule (17), Megajoule (126), Gigajoule (522)\*, Btus (20), Kilo-btus (147), Watt-hours (18), Kilowatt-hours (19), Megawatt-hours (146), Ton-hours (22)

\*Non-Standard BACnet unit

#### Analog Value – YTD Min Power

Property	Default Value	Property Data Type	Access
Object Identifier	AV10	BACnetObjectIdentifier	Read
Object Name	"YTD Min Power"	CharacterString	Read
Object Type	ANALOG_VALUE (2)	BACnetObjectType	Read
Present Value	Current reading	Real	Read
Status Flags	0	BACnetStatusFlags	Read
Event State	Normal (0)	BACnetEventState	Read
Reliability	NO_FAULT_DETECTED (0)	BACnetReliability	Read
Out of Service	FALSE (0)	Boolean	Read/Write
Units	Kilojoule (17)	BACnetEngineeringUnits	Read/Write
Property List		BACnetARRAY[N] of BACnetPropertyIdentifier	Read

Supported Units:

Kilojoule (17), Megajoule (126), Gigajoule (522)\*, Btus (20), Kilo-btus (147), Watt-hours (18), Kilowatt-hours (19), Megawatt-hours (146), Ton-hours (22)

\*Non-Standard BACnet unit

#### Analog Value – MTD Max Power

Property	Default Value	Property Data Type	Access
Object Identifier	AV11	BACnetObjectIdentifier	Read
Object Name	"MTD Max Power"	CharacterString	Read
Object Type	ANALOG_VALUE (2)	BACnetObjectType	Read
Present Value	Current reading	Real	Read
Status Flags	0	BACnetStatusFlags	Read
Event State	Normal (0)	BACnetEventState	Read
Reliability	NO_FAULT_DETECTED (0)	BACnetReliability	Read
Out of Service	FALSE (0)	Boolean	Read/Write
Units	Kilojoule (17)	BACnetEngineeringUnits	Read/Write
Property List		BACnetARRAY[N] of BACnetPropertyIdentifier	Read

Supported Units:

Kilojoule (17), Megajoule (126), Gigajoule (522)\*, Btus (20), Kilo-btus (147), Watt-hours (18), Kilowatt-hours (19), Megawatt-hours (146), Ton-hours (22)

\*Non-Standard BACnet unit

#### Analog Value – MTD Min Power

Property	Default Value	Property Data Type	Access
Object Identifier	AV12	BACnetObjectIdentifier	Read
Object Name	"MTD Min Power"	CharacterString	Read
Object Type	ANALOG_VALUE (2)	BACnetObjectType	Read
Present Value	Current reading	Real	Read
Status Flags	0	BACnetStatusFlags	Read
Event State	Normal (0)	BACnetEventState	Read
Reliability	NO_FAULT_DETECTED (0)	BACnetReliability	Read
Out of Service	FALSE (0)	Boolean	Read/Write
Units	Kilojoule (17)	BACnetEngineeringUnits	Read/Write
Property List		BACnetARRAY[N] of BACnetPropertyIdentifier	Read

Supported Units:

Kilojoule (17), Megajoule (126), Gigajoule (522)\*, Btus (20), Kilo-btus (147), Watt-hours (18), Kilowatt-hours (19), Megawatt-hours (146), Ton-hours (22)

\*Non-Standard BACnet unit

### Analog Value – Inlet YTD Average Temperature

Property	Default Value	Property Data Type	Access
Object Identifier	AV13	BACnetObjectIdentifier	Read
Object Name	"Inlet YTD Average Temperature"	CharacterString	Read
Object Type	ANALOG_VALUE (2)	BACnetObjectType	Read
Present Value	Current reading	Real	Read
Status Flags	0	BACnetStatusFlags	Read
Event State	Normal (0)	BACnetEventState	Read
Reliability	NO_FAULT_DETECTED (0)	BACnetReliability	Read
Out of Service	FALSE (0)	Boolean	Read/Write
Units	Degrees-Celsius (62)	BACnetEngineeringUnits	Read/Write
Property List		BACnetARRAY[N] of BACnetPropertyIdentifier	Read

Supported Units:  
 Degrees-Celsius (62), Degrees-Kelvin (63), Degrees-Fahrenheit (64), Degrees-Rankine (523)\*  
 \*Non-Standard BACnet unit

### Analog Value – Outlet YTD Average Temperature

Property	Default Value	Property Data Type	Access
Object Identifier	AV14	BACnetObjectIdentifier	Read
Object Name	"Outlet YTD Average Temperature"	CharacterString	Read
Object Type	ANALOG_VALUE (2)	BACnetObjectType	Read
Present Value	Current reading	Real	Read
Status Flags	0	BACnetStatusFlags	Read
Event State	Normal (0)	BACnetEventState	Read
Reliability	NO_FAULT_DETECTED (0)	BACnetReliability	Read
Out of Service	FALSE (0)	Boolean	Read/Write
Units	Degrees-Celsius (62)	BACnetEngineeringUnits	Read/Write
Property List		BACnetARRAY[N] of BACnetPropertyIdentifier	Read

Supported Units:  
 Degrees-Celsius (62), Degrees-Kelvin (63), Degrees-Fahrenheit (64), Degrees-Rankine (523)\*  
 \*Non-Standard BACnet unit

### Analog Value – Heat Changeover Temperature

Property	Default Value	Property Data Type	Access
Object Identifier	AV15	BACnetObjectIdentifier	Read
Object Name	"Heat Changeover Temperature"	CharacterString	Read
Object Type	ANALOG_VALUE (2)	BACnetObjectType	Read
Present Value	Current reading	Real	Read/Write
Status Flags	0	BACnetStatusFlags	Read
Event State	Normal (0)	BACnetEventState	Read
Reliability	NO_FAULT_DETECTED (0)	BACnetReliability	Read
Out of Service	FALSE (0)	Boolean	Read/Write
Units	Degrees-Celsius (62)	BACnetEngineeringUnits	Read/Write
Property List		BACnetARRAY[N] of BACnetPropertyIdentifier	Read

### Present Value

Default Value	Minimum Value	Maximum Value
25.0°C	0.0°C	120.0°C

The inlet temperature is compared to this value to determine when energy can be accumulated and if that energy is heat energy.

Supported Units:  
 Degrees-Celsius (62), Degrees-Kelvin (63), Degrees-Fahrenheit (64), Degrees-Rankine (523)\*  
 \*Non-Standard BACnet unit

### Analog Value – Process Pressure

Property	Default Value	Property Data Type	Access
Object Identifier	AV16	BACnetObjectIdentifier	Read
Object Name	"Process Pressure"	CharacterString	Read
Object Type	ANALOG_VALUE (2)	BACnetObjectType	Read
Present Value	232.0604	Real	Read/Write
Status Flags	0	BACnetStatusFlags	Read
Event State	Normal (0)	BACnetEventState	Read
Reliability	NO_FAULT_DETECTED (0)	BACnetReliability	Read
Out of Service	FALSE (0)	Boolean	Read/Write
Units	Pounds-force-per-square-inch (56)	BACnetEngineeringUnits	Read/Write
Property List		BACnetARRAY[N] of BACnetPropertyIdentifier	Read

### Present Value

Default Value	Minimum Value	Maximum Value
232.060 psi	2.901 psi	400.304 psi

This value is used in the energy calculation.

Supported Units:  
 Pounds-force-per-square-inch (56), Kilopascals (54)

### Analog Value – Ethylene Glycol Concentration

Property	Default Value	Property Data Type	Access
Object Identifier	AV17	BACnetObjectIdentifier	Read
Object Name	"Ethylene Glycol Concentration"	CharacterString	Read
Object Type	ANALOG_VALUE (2)	BACnetObjectType	Read
Present Value	0	Real	Read/Write
Status Flags	0	BACnetStatusFlags	Read
Event State	Normal (0)	BACnetEventState	Read
Reliability	NO_FAULT_DETECTED (0)	BACnetReliability	Read
Out of Service	FALSE (0)	Boolean	Read/Write
Units	Percent (98)	BACnetEngineeringUnits	Read
Property List		BACnetARRAY[N] of BACnetPropertyIdentifier	Read

#### Present Value

Default Value	Minimum Value	Maximum Value
0%	0%	100%

This value indicates the amount of Ethylene Glycol by volume in the process fluid.

### Binary Value – Reverse Flow

Property	Default Value	Property Data Type	Access
Object Identifier	BV1	BACnetObjectIdentifier	Read
Object Name	"Reverse Flow"	CharacterString	Read
Object Type	BINARY_VALUE (5)	BACnetObjectType	Read
Present Value	Current Value	BACnetBinaryPV	Read
Status Flags	0	BACnetStatusFlags	Read
Event State	NORMAL (0)	BACnetEventState	Read
Reliability	NO_FAULT_DETECTED(0)	BACnetReliability	Read
Out Of Service	FALSE (0)	Boolean	Read/Write
Property List		BACnetARRAY[N] of BACnetPropertyIdentifier	Read

This value indicates whether or not the direction of the process flow is reversed relative to the arrow mark on the product label.

Present Value: Inactive (0) – Process fluid flow direction not reversed, Active (1) – Process fluid flow direction reversed.

This object supports COV notifications.

### Binary Value – Empty Pipe

Property	Default Value	Property Data Type	Access
Object Identifier	BV2	BACnetObjectIdentifier	Read
Object Name	"Empty Pipe"	CharacterString	Read
Object Type	BINARY_VALUE (5)	BACnetObjectType	Read
Present Value	Current Value	BACnetBinaryPV	Read
Status Flags	0	BACnetStatusFlags	Read
Event State	NORMAL (0)	BACnetEventState	Read
Reliability	NO_FAULT_DETECTED(0)	BACnetReliability	Read
Out Of Service	FALSE (0)	Boolean	Read/Write
Property List		BACnetARRAY[N] of BACnetPropertyIdentifier	Read

This value indicates whether or not the meter detects process fluid at the location of the probe.

Present Value: Inactive (0) – Process fluid detected, Active (1) – Process fluid not detected

This object supports COV notifications.

### Binary Value – Reset Total Flow

Property	Default Value	Property Data Type	Access
Object Identifier	BV3	BACnetObjectIdentifier	Read
Object Name	"Reset Total Flow"	CharacterString	Read
Object Type	BINARY_VALUE (5)	BACnetObjectType	Read
Present Value	Inactive (0)	BACnetBinaryPV	Read/Write
Status Flags	0	BACnetStatusFlags	Read
Event State	NORMAL (0)	BACnetEventState	Read
Reliability	NO_FAULT_DETECTED(0)	BACnetReliability	Read
Out Of Service	FALSE (0)	Boolean	Read/Write
Property List		BACnetARRAY[N] of BACnetPropertyIdentifier	Read

Writing a value of 1 to the present value of this object will reset the value of Total Flow to 0. Writing a value of 0 has no effect.

### Binary Value – Reset Energy Statistics

Property	Default Value	Property Data Type	Access
Object Identifier	BV4	BACnetObjectIdentifier	Read
Object Name	"Reset Energy Statistics"	CharacterString	Read
Object Type	BITSTRING_VALUE (39)	BACnetObjectType	Read
Present Value	Inactive (0)	BACnetBinaryPV	Read/Write
Status Flags	0	BACnetStatusFlags	Read
Event State	NORMAL (0)	BACnetEventState	Read
Reliability	NO_FAULT_DETECTED(0)	BACnetReliability	Read
Out Of Service	FALSE (0)	Boolean	Read/Write
Property List		BACnetARRAY[N] of BACnetPropertyIdentifier	Read

Writing a value of 1 to the present value of this object will reset all the energy statistics to default values. Writing a value of 0 has no effect.

Objects affected: Total Energy (AV5), Heat Energy (AV6), Cooling Energy (AV7), YTD Max Power (AV9), YTD Min Power (AV10), MTD Max Power (AV11), MTD Min Power (AV12), Inlet YTD Average Temperature (AV13), Outlet YTD Average Temperature (AV14), YTD Max Power Date (DV1), YTD Min Power (DV2), MTD Max Power (DV3), MTD Min Power (DV4), Energy Hour Counter (PIV1)

### Bit-String Value – Flow Meter Status Flags

Property	Default Value	Property Data Type	Access
Object Identifier	BSV1	BACnetObjectIdentifier	Read
Object Name	"Flow Meter Status Flags"	CharacterString	Read
Object Type	BITSTRING_VALUE (39)	BACnetObjectType	Read
Present Value	{}	BitString	Read
Status Flags	0	BACnetStatusFlags	Read
Event State	NORMAL (0)	BACnetEventState	Read
Reliability	NO_FAULT_DETECTED(0)	BACnetReliability	Read
Out Of Service	FALSE (0)	Boolean	Read/Write
Property List		BACnetARRAY[N] of BACnetPropertyIdentifier	Read

Bit	Meaning when Set (1)
0	Error: Problem reading/writing NV storage
1	Error: Problem communicating with BTU module
2	Error: Problem communication with ADC
3	Error: Device recovered from Watchdog reset
4	Error: Factory settings invalid (using defaults)
5	Error: Wiring Board not installed/detected
6	Error: Flyback/Output board not installed/detected
7	Error: BTU board not installed/detected
8	Error: AFE board not installed/detected
9	Error: Coil Driver board not installed/detected
10	Error: Measured value is invalid
11	Error: Process Temperature Probe Missing/Broken
12	Error: Some Test Mode Active

### Bit-String Value – Energy Meter Status Flags

Property	Default Value	Property Data Type	Access
Object Identifier	BSV2	BACnetObjectIdentifier	Read
Object Name	"Energy Meter Status Flags"	CharacterString	Read
Object Type	BITSTRING_VALUE (39)	BACnetObjectType	Read
Present Value	{}	BitString	Read
Status Flags	0	BACnetStatusFlags	Read
Event State	NORMAL (0)	BACnetEventState	Read
Reliability	NO_FAULT_DETECTED(0)	BACnetReliability	Read
Out Of Service	FALSE (0)	Boolean	Read/Write
Property List		BACnetARRAY[N] of BACnetPropertyIdentifier	Read

Bit	Meaning when Set (1)
0	Error: Problem reading/writing NV storage
1	Error: Problem communicating with RTC
2	Error: Problem communication with ADC
3	Error: Device recovered from Watchdog reset
4	Error: Device recovered from External Reset
5	Error: Factory settings invalid (using defaults)
6	Error: Inlet temperature invalid
7	Error: Inlet Probe open circuit
8	Error: Inlet Probe short circuit
9	Error: Outlet temperature invalid
10	Error: Outlet Probe open circuit
11	Error: Outlet Probe short circuit
12	Error: Measured value is invalid
13	Error: Temperature delta is outside the required window
14	Error: Test Mode Active
15	Error: Calibration Mode Active

**Date Value – YTD Max Power Date**

Property	Default Value	Property Data Type	Access
Object Identifier	DV1	BACnetObjectIdentifier	Read
Object Name	"YTD Max Power Date"	CharacterString	Read
Object Type	DATE_VALUE (42)	BACnetObjectType	Read
Present Value	Current Value	Date	Read
Status Flags	0	BACnetStatusFlags	Read
Event State	NORMAL (0)	BACnetEventState	Read
Reliability	NO_FAULT_DETECTED(0)	BACnetReliability	Read
Out Of Service	FALSE (0)	Boolean	Read/Write
Property List		BACnetARRAY[N] of BACnetPropertyIdentifier	Read

**Date Value – YTD Min Power Date**

Property	Default Value	Property Data Type	Access
Object Identifier	DV2	BACnetObjectIdentifier	Read
Object Name	"YTD Min Power Date"	CharacterString	Read
Object Type	DATE_VALUE (42)	BACnetObjectType	Read
Present Value	Current Value	Date	Read
Status Flags	0	BACnetStatusFlags	Read
Event State	NORMAL (0)	BACnetEventState	Read
Reliability	NO_FAULT_DETECTED(0)	BACnetReliability	Read
Out Of Service	FALSE (0)	Boolean	Read/Write
Property List		BACnetARRAY[N] of BACnetPropertyIdentifier	Read

**Date Value – MTD Max Power Date**

Property	Default Value	Property Data Type	Access
Object Identifier	DV3	BACnetObjectIdentifier	Read
Object Name	"MTD Max Power Date"	CharacterString	Read
Object Type	DATE_VALUE (42)	BACnetObjectType	Read
Present Value	Current Value	Date	Read
Status Flags	0	BACnetStatusFlags	Read
Event State	NORMAL (0)	BACnetEventState	Read
Reliability	NO_FAULT_DETECTED(0)	BACnetReliability	Read
Out Of Service	FALSE (0)	Boolean	Read/Write
Property List		BACnetARRAY[N] of BACnetPropertyIdentifier	Read

**Date Value – MTD Min Power Date**

Property	Default Value	Property Data Type	Access
Object Identifier	DV4	BACnetObjectIdentifier	Read
Object Name	"MTD Min Power Date"	CharacterString	Read
Object Type	DATE_VALUE (42)	BACnetObjectType	Read
Present Value	Current Value	Date	Read
Status Flags	0	BACnetStatusFlags	Read
Event State	NORMAL (0)	BACnetEventState	Read
Reliability	NO_FAULT_DETECTED(0)	BACnetReliability	Read
Out Of Service	FALSE (0)	Boolean	Read/Write
Property List		BACnetARRAY[N] of BACnetPropertyIdentifier	Read

**Multi-State Value – Velocity Probe Location**

Property	Default Value	Property Data Type	Access
Object Identifier	MSV1	BACnetObjectIdentifier	Read
Object Name	"Velocity Probe Location"	CharacterString	Read
Object Type	MULTI_STATE_VALUE (19)	BACnetObjectType	Read
Present Value	1	Unsigned	Read/Write
Status Flags	0	BACnetStatusFlags	Read
Event State	NORMAL (0)	BACnetEventState	Read
Reliability	NO_FAULT_DETECTED(0)	BACnetReliability	Read
Out Of Service	FALSE (0)	Boolean	Read/Write
State Text	{"Inlet", "Outlet"}	BACnetARRAY[N] of CharacterString	Read
Property List		BACnetARRAY[N] of BACnetPropertyIdentifier	Read

This setting indicates the location of the velocity probe relative to the system. Choose "Inlet" (1) if flow meter is installed in the inlet/supply pipe. Choose "Outlet" (2) if the flow meter is installed in the outlet/return pipe.

**Multi-State Value – RTD Locations**

Property	Default Value	Property Data Type	Access
Object Identifier	MSV1	BACnetObjectIdentifier	Read
Object Name	"Velocity Probe Location"	CharacterString	Read
Object Type	MULTI_STATE_VALUE (19)	BACnetObjectType	Read
Present Value	1	Unsigned	Read/Write
Status Flags	0	BACnetStatusFlags	Read
Event State	NORMAL (0)	BACnetEventState	Read
Reliability	NO_FAULT_DETECTED(0)	BACnetReliability	Read
Out Of Service	FALSE (0)	Boolean	Read/Write
State Text	{"RTD1 in Inlet/RTD2 in Outlet", "RTD1 in Outlet/RTD2 in Inlet"}	BACnetARRAY[N] of CharacterString	Read
Property List		BACnetARRAY[N] of BACnetPropertyIdentifier	Read

This setting indicates the relationship between the temperature inputs and the probe locations.

**Date Value – YTD Max Power Date**

Property	Default Value	Property Data Type	Access
Object Identifier	PIV1	BACnetObjectIdentifier	Read
Object Name	"Energy Hour Counter"	CharacterString	Read
Object Type	POSITIVE_INTEGER_VALUE (48)	BACnetObjectType	Read
Present Value	Current value	Date	Read
Status Flags	0	BACnetStatusFlags	Read
Event State	NORMAL (0)	BACnetEventState	Read
Reliability	NO_FAULT_DETECTED(0)	BACnetReliability	Read
Out Of Service	FALSE (0)	Boolean	Read/Write
Units	Hours (71)	BACnetARRAY[N] of CharacterString	Read
Property List		BACnetARRAY[N] of BACnetPropertyIdentifier	Read

This value conveys the time, in hours, for which energy has been accumulated.

**BACnet Services**

**Device Communication Control Service (DM-DCC-B)**

This device supports the Device Communication Control Service BIBB. The optional time duration in minutes is also supported. This device is configured with a password that must be provided to successfully execute this command. The password is "Dwyer".

**Reinitialize Device Service (DM-RD-B)**

This device supports the Reinitialize Device Service BIBB. The supported device states are COLDSTART and WARMSTART. All other states return error. This device is configured with a password that must be provided to successfully execute this command. The password is "Dwyer".

**SubscribeCOV Service (DS-COV-B)**

This device supports the SubscribeCOV Service BIBB to allow easy monitoring of input data.

- Up to seven (7) concurrent subscriptions
- Confirmed and Unconfirmed COV Notifications
- Fixed lifetime value up to 86400 seconds (24 hours).

Indefinite lifetime supported.

**TimeSynchronization Service (DM-TS-B) and UTCTimeSynchronization Service (DM-UTC-B)**

This device supports both time synchronization services for easy time management and update.

When using UTCTimeSynchronization, day light savings will not be applied automatically. The daylight\_savings\_status property of the device object must be written appropriately to adjust for daylight savings time.



## MODBUS®

### Modbus® Functions

The device supports the following functions

Function Name	Function Code
Read Holding Registers	03
Read Input Registers	04
Write Single Register	06
Write Multiple Registers	16

### Modbus® Registers

Input Registers

Register	Description	Data Type	Range
0001-0002	Velocity	32bit Float	
0003-0004	Volume Flow	32bit Float	
0005-0006	Mass Flow	32bit Float	
0007-0008	Total Flow	32bit Float	
0009	Reverse Flow	Unsigned 16bit Integer	
0010	Empty Pipe	Unsigned 16bit Integer	
0011-0012	Flow Meter Status	Unsigned 32bit Integer	See BACnet "Flow Meter Status Flags"
0013-0014	Power	32bit Float	
0015-0016	Total Energy	32bit Float	
0017-0018	Inlet Temperature	32bit Float	
0019-0020	Outlet Temperature	32bit Float	
0021-0022	Temperature Difference	32bit Float	
0023-0024	Heat Energy	32bit Float	
0025-0026	Cooling Energy	32bit Float	
0027-0028	Energy Totalized Hour Counter	Unsigned 32bit Integer	
0029-0030	YTD Max Power	32bit Float	
0031	YTD Max Power Date: Year	Unsigned 16bit Integer	
0032	YTD Max Power Date: Month	Unsigned 16bit Integer	
0033	YTD Max Power Date: Day	Unsigned 16bit Integer	
0034-0035	YTD Min Power	32bit Float	
0036	YTD Min Power Date: Year	Unsigned 16bit Integer	
0037	YTD Min Power Date: Month	Unsigned 16bit Integer	
0038	YTD Min Power Date: Day	Unsigned 16bit Integer	
0039-0040	MTD Max Power	32bit Float	
0041	MTD Max Power Date: Year	Unsigned 16bit Integer	
0042	MTD Max Power Date: Month	Unsigned 16bit Integer	
0043	MTD Max Power Date: Day	Unsigned 16bit Integer	
0044-0045	MTD Min Power	32bit Float	
0046	MTD Min Power Date: Year	Unsigned 16bit Integer	
0047	MTD Min Power Date: Month	Unsigned 16bit Integer	
0048	MTD Min Power Date: Day	Unsigned 16bit Integer	
0049-0050	Inlet YTD Average Temperature	32bit Float	
0051-0052	Outlet YTD Average Temperature	32bit Float	
0053-0054	Energy Meter Status	Unsigned 32bit Integer	See BACnet "Energy Meter Status Flags"
8001-8016	Model Number	String	Example: "IEF-HN-10-COM" or "IEFB-HN-PG-R10-COM"
8017-8020	Flow Meter Serial Number	String	"xxxxxxx"
8021-8028	Flow Meter Firmware Version	String	"x.x.x"
8029-8032	Flow Meter Date Code	String	"xxxx"
8033-8036	Energy Meter Serial Number	String	"xxxxxxx"
8037-8044	Energy Meter Firmware Version	String	"x.x.x"
8045-8048	Energy Meter Date Code	String	"xxxx"

The String data type is read as a stream of ASCII characters with the first character sent in the MSB of the first register and the second character sent in the LSB of the first register and so on. If the string is shorter than the allotted size, the remaining bytes will be zero padded.

**Holding Registers**

Register	Description	Data Type	Range
0001-0020	Device Name	String	
0021	Velocity Unit	Unsigned 16bit integer	0-7
0022	Volume Flow Unit	Unsigned 16bit integer	0-15
0023	Volume Unit	Unsigned 16bit integer	0-3
0024-0025	% Ethylene Glycol Concentration	32bit Float	0-100
0026	Reset Total Flow	Unsigned 16bit integer	0 or 1
0027	Reset Energy Statistics	Unsigned 16bit integer	0 or 1
0028	Power Unit	Unsigned 16bit integer	0-8
0029	Energy Unit	Unsigned 16bit integer	0-8
0030	Temperature Unit	Unsigned 16bit integer	0-3
0031	Mass Flow Unit	Unsigned 16bit integer	0-7
0032	Pressure Unit	Unsigned 16bit integer	0 or 1
0033	Current Date – Year	Unsigned 16bit integer	2000-2099
0034	Current Date – Month	Unsigned 16bit integer	1-12
0035	Current Date – Day	Unsigned 16bit integer	1-31
0036	Current Time – Hour	Unsigned 16bit integer	0-23
0037	Current Time – Minute	Unsigned 16bit integer	0-59
0038	Current Time – Second	Unsigned 16bit integer	0-59
0039	Update Date & Time	Unsigned 16bit integer	0 or 1
0040	Velocity Probe Location	Unsigned 16bit integer	0 or 1
0041	RTD Location	Unsigned 16bit integer	0 or 1
0042-0043	Heating Changeover Temperature	32bit Float	32 - 248°F (0-120°C)
0044-0045	Process Pressure	32bit Float	2.9-400 psi
0046	Reset Device	Unsigned 16bit integer	0 or 1

**Device Name:** A string, up to 40 characters long, that will be displayed on the LCD (if present). When reading or writing, all 20 registers must be requested. Strings less than 40 characters shall be 0 padded.

**Velocity Unit:** Selects the unit of velocity for the value in the velocity register. See Table 1.

**Flow Unit:** Selects the unit of flow for the value in the Flow register. See Table 2.

**Volume Unit:** Selects the unit of volume for the value in the Total Flow register. See Table 3.

**Power Unit:** Selects the unit of power for the value in the Power, YTD Max Power, YTD Min Power, MTD Max Power, MTD Min Power, YTD Average Inlet Temperature and YTD Average Outlet Temperature registers. See Table 4.

**Energy Unit:** Selects the unit of energy for the value in the Total Energy, Heating Energy and Cooling Energy registers. See Table 5.

**Temperature Unit:** Selects the unit of temperature for the values in the Inlet Temperature, Outlet Temperature and Temperature Difference registers. See Table 6.

**Mass Flow Unit:** Selects the unit of mass flow for the value in the Mass Flow register. See Table 7

**Pressure Unit:** Selects the unit of pressure for the value in the Process Pressure register. See Table 8

**Reset Total Flow:** When a value of 1 is written to this register, the value in the Total Flow register is reset to 0. Writing a value of 0 has no effect. This register will always return a 0 when read.

**Rest Device:** When a value of 1 is written to this register, the device will perform a warm reset after 5 seconds. Writing a value of 0 has no effect. This register will always return 0 when read.

**Setting the Date and Time:**

The IEFB contains a battery backed real-time clock. Current date and time can be set with the current date and current time registers. Note, however, that the date and time will not be updated until a value of 1 is written to the Update Date & Time register. To ensure the best possible time accuracy, it is recommended to write all the data and time registers including the Update Data & Time register is a single Modbus® transaction.

**Velocity Probe Location:**

This setting indicates where in the system the flow meter is installed with respect to the Inlet/Outlet RTDs. See Table 9

**RTD Location Mapping:**

This setting determines where each RTD channel is installed. By default, RTD1 should be installed in the Inlet and RTD2 should be installed in the Outlet. However, if the process can flow in reverse (where the Inlet becomes the Outlet) this value will need to change as well as the Velocity Probe Location.

**Heating Changeover Temperature:**

Heating Energy is accumulated when the Inlet temperature is greater than the heating changeover temperature and the Outlet temperature. Similarly, Cooling Energy is accumulated when the Inlet temperature is less than the heating changeover temperature and the Outlet temperature.

**Process Pressure:**

The average or normal pressure of the process fluid. This value is used to determine the density of the process fluid in order to compute power and energy correctly.

VELOCITY UNIT VALUES	
Value	Unit
*0	Feet-per-second (ft/s)
1	Feet-per-minute (ft/min)
2	Feet-per-hour (ft/hr)
3	Feet-per-day (ft/day)
4	Meters-per-second (m/s)
5	Meters-per-minute (m/min)
6	Meters-per-hour (m/hr)
7	Meters-per-day (m/day)

Table 1

VOLUME UNIT VALUES	
Value	Unit
0	Cubic-feet (ft³)
*1	Gallons (gal)
2	Liters (L)
3	Cubic-meters (m³)

Table 2

FLOW UNIT VALUES	
Value	Unit
*0	Cubic-feet-per-second (ft³/s)
1	Cubic-feet-per-minute (ft³/min)
2	Cubic-feet-per-hour (ft³/hr)
3	Cubic-feet-per-day (ft³/day)
4	Gallons-per-second (gal/s)
5	Gallons-per-minute (gal/min)
6	Gallons-per-hour (gal/hr)
7	Gallons-per-day (gal/day)
8	Liters-per-second (L/s)
9	Liters-per-minute (L/min)
10	Liters-per-hour (L/hr)
11	Liters-per-day (L/day)
12	Cubic-meters-per-second (m³/s)
13	Cubic-meters-per-minute (m³/min)
14	Cubic-meters-per-hour (m³/hr)
15	Cubic-meters-per-day (m³/day)

Table 3

\*Default unit

POWER UNIT VALUES	
Value	Unit
0	Watt (W)
*1	Kilowatt (kW)
2	Megawatt (MW)
3	Joules-per-hour (J/h)
4	Kilojoules-per-hour (kJ/h)
5	Gigajoules-per-hour (GJ/h)
6	Btu-per-hour (Btu/h)
7	Kilo-Btu-per-hour (kBtu/h)
8	ton

Table 4

ENERGY UNIT VALUES	
Value	Unit
0	Kilojoule (kJ)
1	Megajoule (MJ)
2	Gigajoule (GJ)
3	Btu
4	Kilo-Btu (kBtu)
5	Watt-hour (Wh)
*6	Kilowatt-hour (kWh)
7	Megawatt-hour (MWh)
8	ton-hour

Table 5

TEMPERATURE UNIT VALUES	
Value	Unit
*0	Fahrenheit (°F)
1	Rankine (R)
2	Celsius (°C)
3	Kelvin (K)

Table 6

MASS FLOW UNIT VALUES	
Value	Unit
*0	Pounds-mass-per-second (lb/s)
1	Pounds-mass-per-minute (lb/min)
2	Pounds-mass-per-hour (lb/hr)
3	Pounds-mass-per-day (lbm/day)
4	Kilograms-per-second (kg/s)
5	Kilograms-per-minute (kg/min)
6	Kilograms-per-hour (kg/s)
7	Kilograms-per-day (kg/day)

Table 7

PRESSURE UNIT VALUES	
Value	Unit
*0	Pounds-per-square-inch (psi)
1	Kilopascals (kPa)

Table 8

VELOCITY PROBE LOCATION VALUES	
Value	Unit
*0	Inlet
1	Outlet

Table 9

RTD LOCATION MAPPING	
Value	Unit
*0	RTD1 in Inlet, RTD2 in Outlet
1	RTD1 in Outlet, RTD2 in Inlet

Table 10

### Multi-Address Support

Multi-Address support allows a register to be read or written to using different byte orientations specified by the address range. For example, input register 0003 can also be read at 2003, 4003 and 6003 with different byte orientations as listed in Table 7. Registers that do not have multi-address support are only available in Big-Endian byte orientation (Modbus® standard).

	Address Range	Float/32bit Values				16Bit Values	
		Register 1		Register 2		Register 1	
Byte Order		MSB		LSB		MSB	LSB
Big-Endian	1-2000	A	B	C	D	A	B
Byte Swap	2001-4000	B	A	D	C	B	A
Word Swap	4001-6000	C	D	A	B	A	B
Little-Endian	6001-8000	D	C	B	A	B	A

**Electronic Control Setup -LCD Display Option or A-IEF-DSP Accessory**  
**Basic information**

1. Turn on the power to the Display/Menu.

**NOTICE**

At power ON, the Dwyer Logo, Serial Number and Firmware Version of the meter is displayed.

2. If a meter is NOT custom-configured, the setup wizard starts.
3. If the meter is configured, the process data is displayed.



**Navigation Basics**

1. The UP /DOWN buttons change the selected option or increase or decrease the current value.
2. The RIGHT button advances the display to the next menu without changing the current setting.
3. The LEFT button returns the display to the previous menu without changing the current setting.
4. The ENTER button accepts the selected setting or value and advances to the next menu.
5. The MENU button transitions the display to the main menu. Any unsaved changes will be lost.



**Menu Basics**

1. Option Menus:
  - The current option is indicated by a highlight bar. The highlight bar is moved with the UP and DOWN buttons.
  - The active option is indicated by an asterisk (\*) symbol to the far right of the option name.
2. Value Menus:
  - The active value is always displayed when the menu is displayed.
  - To reset a changed value to the active value, use the LEFT button to return to the previous menu, then the RIGHT button to advance to the value menu again.
3. Press & Hold the UP or DOWN button to continuously increase or decrease the value.
 

**Note:** The longer the button is held, the more quickly the value will be increased or decreased.

**Main Configuration Wizard**

1. Language Selection:
  - At the Language Screen select the Language:
  - The menu default language is English.
  - If necessary, select another language by moving the highlighted bar with the UP /DOWN Arrows and press the Enter Button to select the Language.



2. Unit System Selection Menu:
  - This option determines which units will be available in future menus.
  - The Default is English
  - If necessary, select a different Unit of measure by moving the highlighted bar with the UP /DOWN Arrows and press the Enter button to select the Unit.



3. Velocity Unit Menu:
  - This option determines how the calculated volume velocity is displayed.
  - The Default is Feet-Per-Second.

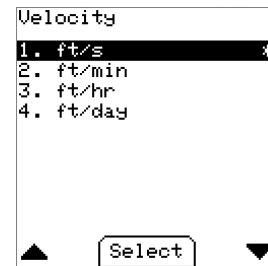

4. Flow Unit Menu:
  - This option determines how the calculated volume flow is displayed.
  - The Default is Cubic-Foot-Per-Second.

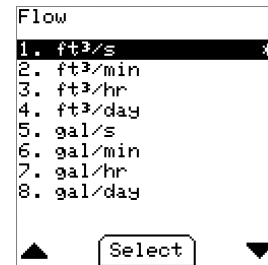

5. Mass Flow Unit Menu:
- This option determines how the mass flow is displayed.
  - The Default is pounds-mass-per-hour.

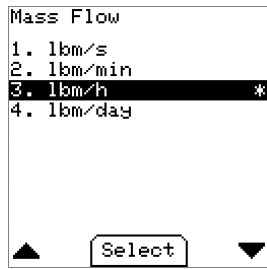

6. Volume Unit Menu:
- This option determines how the totalized flow is displayed.
  - The Default is Gallons.

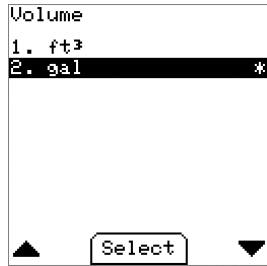

7. Temperature Menu:
- This option determines how the temperature is displayed.
  - The Default is degrees Fahrenheit.

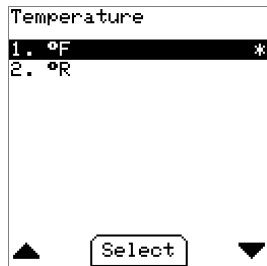

8. Power Menu:
- This option determines how the power is displayed.
  - The Default is kilowatts.

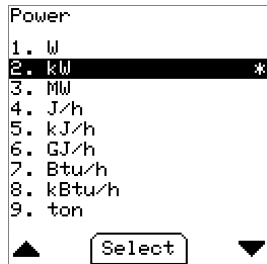

9. Energy Menu:
- This option determines how the energy is displayed.
  - The Default is kilowatt hour.



### Pipe Configuration Wizard

1. Pipe Material Menu:
- This option helps determine the pipe dimensions as well as account for different material properties.
  - The Default is Carbon Steel.

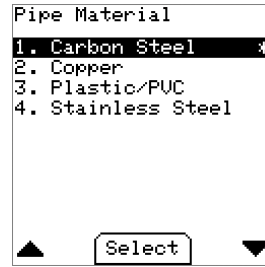

2. Install Kit Menu (High Performance):
- This option determines how the pipe dimensions will be collected.
  - If a high accuracy meter was purchased, then the High Performance Setup must be used to ensure correctness.
  - Default: High Performance Setup.



- a. Pipe Circumference Menu (High Performance):
- This value is the outside circumference of the pipe where the meter is installed.
  - The circumference can be measured with the tape included in the high performance installation kit.
  - Default: 27.096in (~8in diameter)

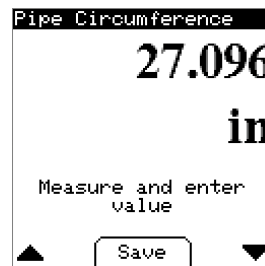

- b. Wall Thickness Menu (High Performance):
- This value is the pipe wall thickness at the point where the meter is installed.
  - The thickness can be measured with the UTG gauge included in the high performance installation kit.
  - Default: 0.322in

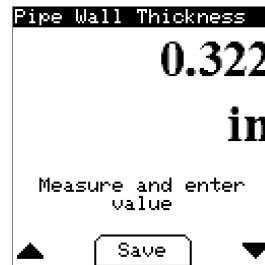

3. Install Kit Menu (Standard):

A. Nominal Pipe Size Menu

- Select the diameter of the installation pipe from the list of standard pipe diameters. If your nominal diameter is not listed or you have actual OD data, select Other and enter the pipe diameter directly.
- Default: 8 in

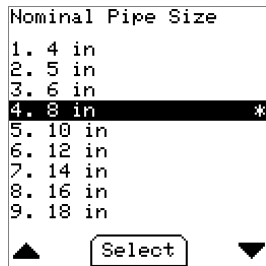

B. Pipe Wall Thickness Menu:

- Select the wall thickness of the installation pipe from the list of standard pipe wall thicknesses.
- If your wall thickness is not listed, select Other and enter the pipe wall thickness directly.
- The options available depend on the pipe material selected.
- Default: Varies with selected pipe material.



4. Pipe Insertion Depth Display:

- This screen shows the calculated insertion depth based on the values previously entered.
- Using the installation alignment kit provided with the IEFB, set the depth to the value displayed on the alignment scale:

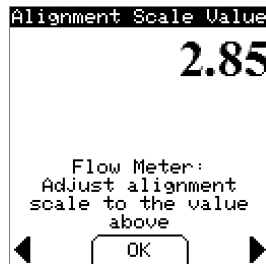
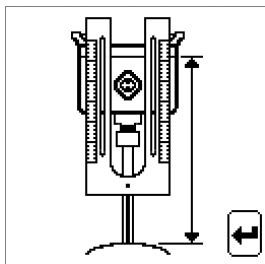

6. Liquid Type Menu:

- This option specifies the process liquid to be measured.
- If Ethylene Glycol is selected, the next menu will allow the concentration to be entered.
- Default: Water

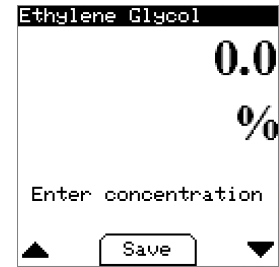
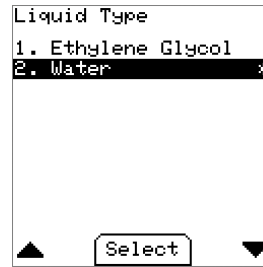

7. Pipe Configuration Summary Display: High Performance:

- This screen shows a summary of the settings entered in the pipe configuration wizard when the high performance set up is used.

8. Continue to Energy Meter Configuration Wizard Question:

- If Continue is selected, the next menu displayed will be in the Energy Meter Configuration Wizard.
- If Save & Exit is selected, the settings and values entered during the Pipe configuration wizard will be stored and put into effect.
- Regardless of the selection, the ENTER button must be pressed to show process data.
- Default: Continue

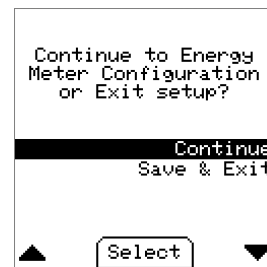

9. Energy Meter Configuration Wizard

A. Flow Meter Location Menu:

- Select the location of the flow meter in the inlet or outlet pipe.
- Default: Inlet.

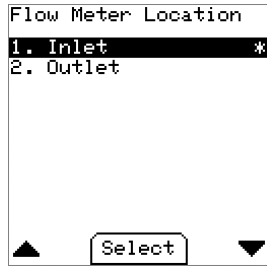

B. RTD Location Mapping Menu:

- Select the location of each RTD in the inlet and outlet pipe.
- Default: RTD 1=Inlet, RTD 2=Outlet.

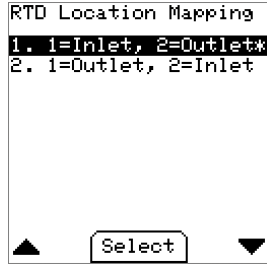

C. Heating Crossover Temperature Menu:

- Input the crossover temperature.
- Default: 77°F.

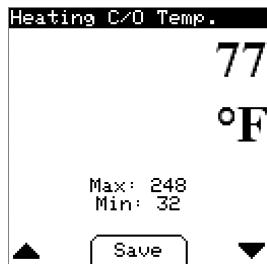

D. Process Pressure Menu:

- Input the process pressure inside the pipe.
- Default: 232.060 PSI.

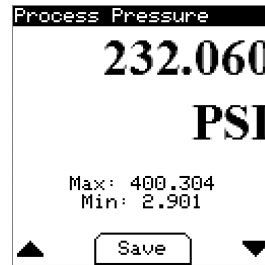

E. Energy Meter Summary Display:

- This screen shows a summary of the settings entered in the Energy Meter configuration wizard.

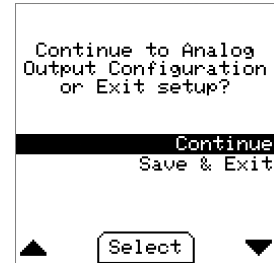
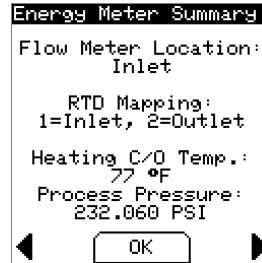

10. Analog Configuration Wizard:

- Analog Output Setup Menu:
- This option determines the type of analog output from the meter.
- Default: Current 4-20 mA

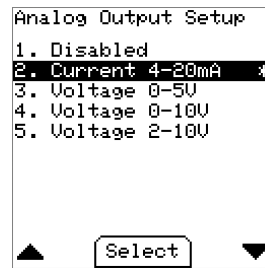

11. Process Variable Menu:

- This option determines which variable is output on the analog signal.
- Default: Velocity

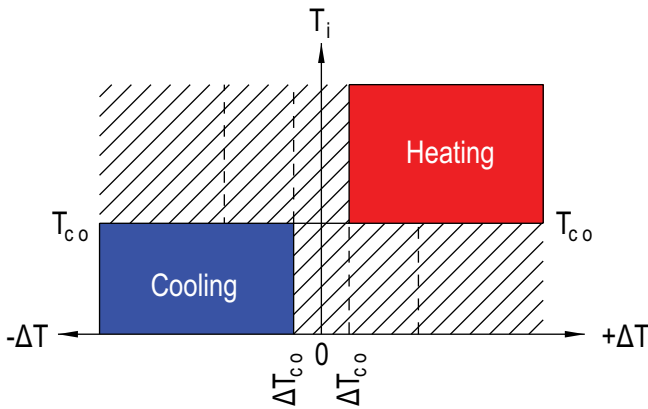
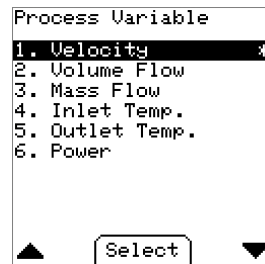

KEY

- No energy recording
- Heating  $T_i > T_{co}$  &  $T_i > T_o$  &  $\Delta T > \Delta T_{co}$
- Cooling  $T_i < T_{co}$  &  $T_i < T_o$  &  $\Delta T < \Delta T_{co}$

$T_{co}$  = Cross over Temp = 25°C Default  
 $\Delta T_{co}$  = Cross over Delta Temp = 0.5 K  
 $T_i$  = Inlet Temp  
 $T_o$  = Outlet Temp  
 $\Delta T = T_i - T_o$

12. Analog Output High Menu:

- This value determines the process value at which the analog output will be at maximum (e.g. 20 mA, 10 V, 5 V).
- Default: 20.0 ft/s.



13. Analog Output Low Menu:

- This value determines the process value at which the analog output will be at minimum (e.g. 4mA, 0V).
- Default: 0.0 ft/s

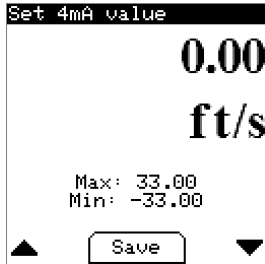

14. Analog Configuration Summary Display:

- This screen shows a summary of the settings entered in the Analog configuration wizard.

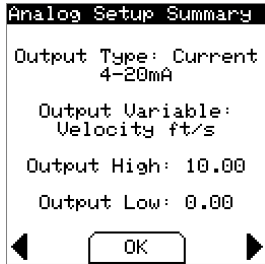

**Pulse/Frequency Wizard:**

- Continue to Pulse/Frequency Configuration Wizard Question:
  - If Continue is selected, the next menu displayed will be in the Pulse/Frequency configuration wizard.
  - If Save & Exit is selected, the settings and values entered during the Analog configuration wizard will be stored and put into effect.
  - Regardless of the selection, the ENTER  button must be pressed to show process data.
  - Default: Continue.

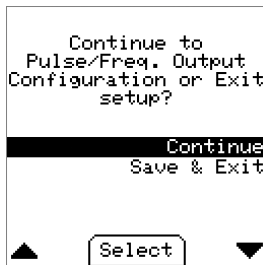

2. Pulse/Frequency Output Menu:

- This option determines the type of digital output from the meter.
- Default: Disabled. 

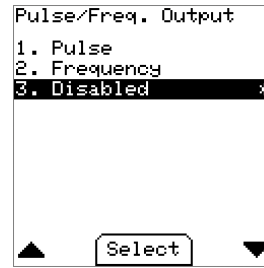

3. Pulse Variable Menu:

- This option determines the output pulse variable.
- Default: Total Flow.

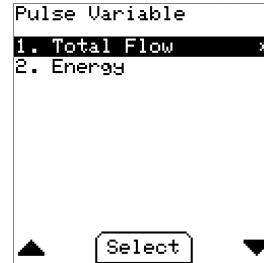

4. Digital Output: Pulse

A. Pulse Scale Menu:

- This value determines the amount to totalized volume between each pulse of the output.
- Default: 7 gallons/pulse.

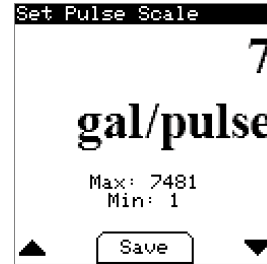

B. Pulse Width Menu:

- This value determines the duration of the pulse when active.
- Default: 150 milliseconds.

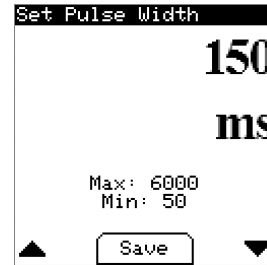

C. Pulse/Frequency Summary Display:

- This screen shows a summary of the pulse settings entered in the Pulse/Frequency configuration wizard.

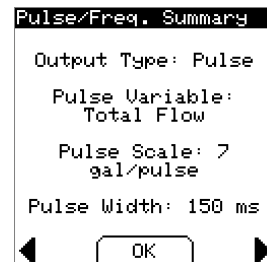



- D. Frequency Output High Menu:
- This value determines the process value at which the frequency output will be at maximum (500Hz).
  - Default: 20.0 ft/s.

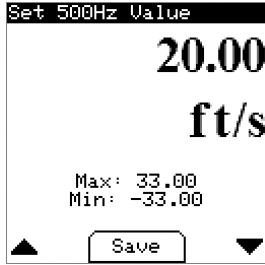

- E. Frequency Output Low Menu:
- This value determines the process value at which the frequency output will be at minimum (0Hz).
  - Default: 0.0 ft/s.

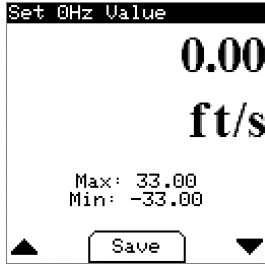

5. Pulse/Frequency Summary Display:
- This screen shows a summary of the frequency settings entered in the Pulse/Frequency configuration wizard.

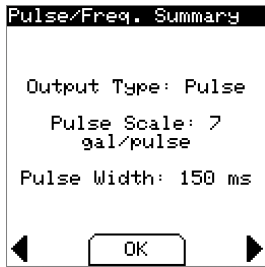

**Alarm Wizard**

1. If Continue is selected, the next menu displayed will be in the Alarm configuration wizard.
2. If Save & Exit is selected, the settings and values entered during the Pulse/Frequency configuration wizard will be stored and put into effect. Then, the display will show process data.
3. Regardless of selection, the ENTER button must be used to choose either option.
  - Default: Continue.

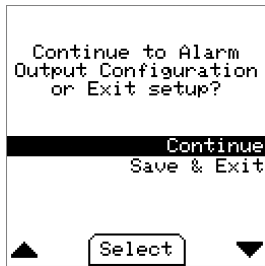

4. Alarm Output Setup Menu:
- This option determines the type of alarm output.
  - Default: Empty Pipe Alarm.

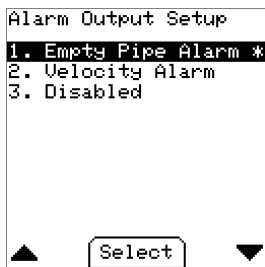

5. Empty Alarm Setup Menu
- This screen displays a summary of the Alarm output configuration. The image displayed indicates the alarm type is Empty Pipe, meaning that when an empty pipe condition is detected, the alarm contact will close.

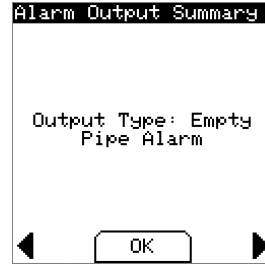

**Velocity Alarm - Outputs:**

1. Alarm Type Menu:
- This option determines how the process velocity is compared to the trigger value. Select either low or high limit.
  - Default: Low Limit.



2. Alarm Trigger Menu:
- This value specifies the velocity at which the alarm is active or inactive.
  - Default: 0.1 ft/s.

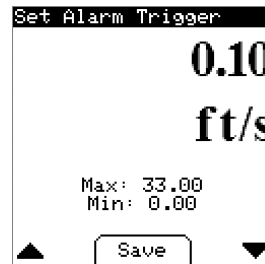

3. Alarm Hysteresis Menu:
- This value defines a range around the trigger value to prevent excessive switching of the alarm output.
  - Default: 0.1 ft/s.



4. Alarm Output Summary Display:
- This screen shows a summary of the settings entered in the Alarm configuration wizard when velocity alarm is selected.

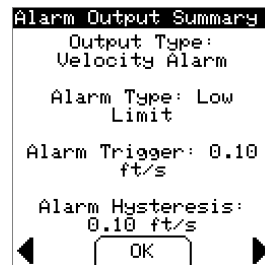

**Communication Configuration Wizard**

1. If Continue is selected, the next menu displayed will be the Communication configuration wizard.
2. If Save & Exit is selected, the settings and values entered during the Alarm configuration wizard will be stored and put into effect.
3. Regardless of the selection, the ENTER  button must be pressed to show process data.
  - Default: Continue.
4. Select Protocol Menu:
  - This option determines the protocol used by the meter over the RS-485 interface.
  - Default: Disabled.

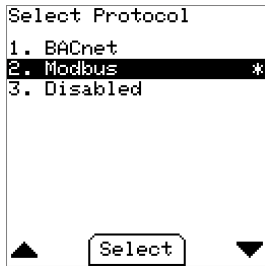

5. Network Address Menu:
  - This value sets the device address on the RS-485 bus. Address range depends on protocol; BACnet Communications Protocol (0-127), Modbus® Communications Protocol (1-247)
  - Default: 127

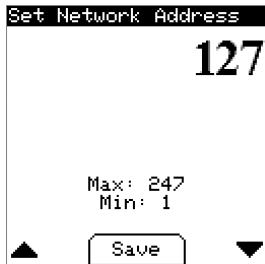

6. Baud Rate Menu:
  - This option selects the communication speed of the RS-485 bus.
  - Default: 19200 (Modbus® Communications Protocol), 38400 (BACnet Communications Protocol)

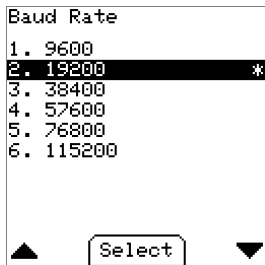

7. Serial Parity Menu (Modbus® Communications Protocol Only):
  - This option sets the serial parity on the RS-485 bus.
  - Default: Even.

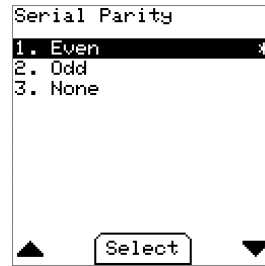

8. Serial Stopbits (Modbus® Communications Protocol Only):
  - The option sets the serial Stopbits on the RS-485 bus.
  - Default: 1.



9. Communication Summary Display:
  - This screen shows a summary of the settings entered in the Communication configuration wizard.



- After the Communication Wizard is complete, the meter setup is complete.
- The display will show Setup Complete and transition to display process Data.



**Process Value Display:**

- This display is the default view after power on of a configured meter or when the Save & Exit option is selected from the Setup Wizard.
- Use the LEFT and RIGHT buttons to toggle between Flow/Velocity, Total Flow, Inlet/Outlet Temperature, Delta Temperature/Power, and Power/Energy views.
- Use the MENU or ENTER button to go to the main menu.

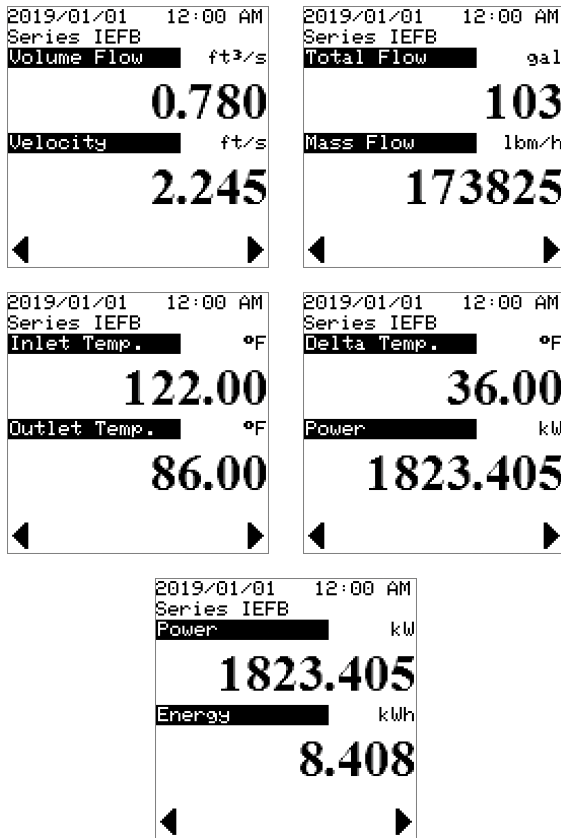

**MAIN MENU**

1. **Language:** Change the language of the display
2. **Units:** Change the display units
3. **Pipe Setup:** Enter the Pipe setup wizard
4. **Energy Meter Setup:** Enter the Energy Meter wizard
5. **Analog Output Setup:** Enter the Analog Output wizard
6. **Pulse/Frequency Output Setup:** Enter the Pulse/Frequency wizard
7. **Alarm Output Setup:** Enter the Alarm Output wizard
8. **Communication Setup:** Enter the Communication wizard
9. **Save Setup File:** Save the current setup to a file
10. **Device Information:** Show the summary displays from each wizard and other meter/display information
11. **Reset Flow Total:** Reset totalized flow value
12. **Reset Energy Statistic:** Reset stored energy statistic
13. **Damping:** Sets the amount that velocity is averaged.
14. **Calibration Factor:** Configure custom velocity multiplier
15. **Date & Time Setup:** Change the date and time
16. **Indicator Display Setup:** Set up the indicator display
17. **Save Defaults:** Save the current settings as the user default values
18. **Restore Defaults:** Restore the previously saved user settings



**Device Information**

- A list of all setting summaries. Use RIGHT and LEFT buttons to move between the various summary pages.

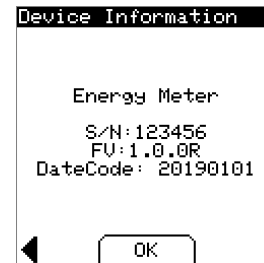
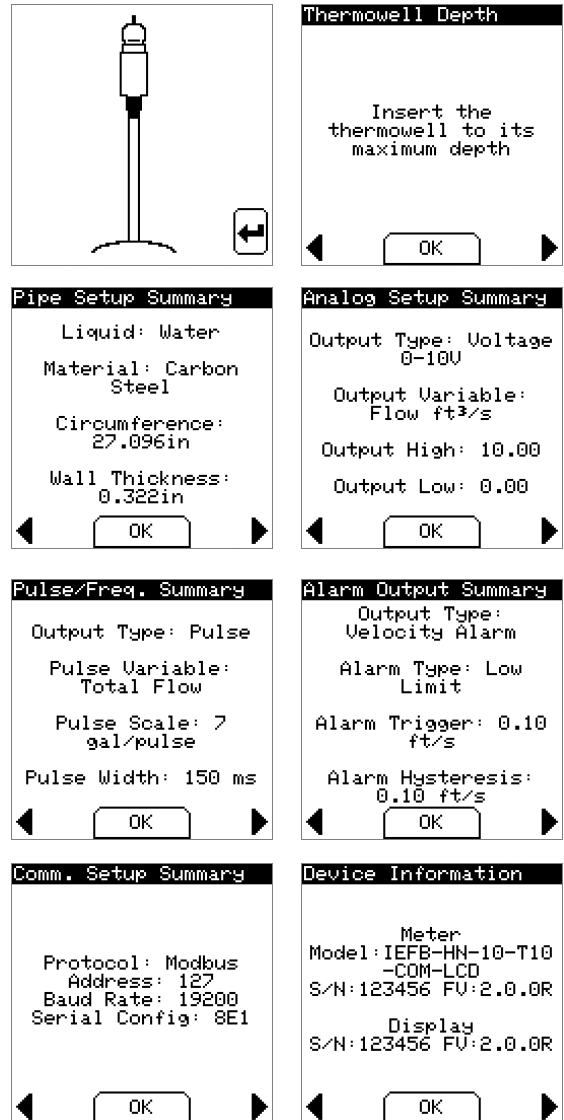

**Date & Time Setup:**

- This menu sets up the date and time on the IEFB.
  - Select Time Format to set time.



- Set Time Format:
  - This option selects 12 or 24 hour time format.
  - Default: 12 hour.

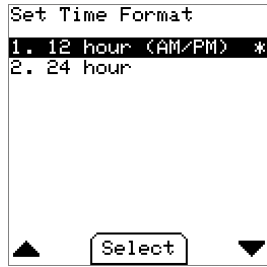

- Set Daylight Savings:
  - This option sets daylight savings time as active or inactive.
  - Default: Inactive.



- Set Date:
  - This option sets the date in YYYY/MM/DD format.
  - Use the up/down arrow keys to input the year, month, and day.

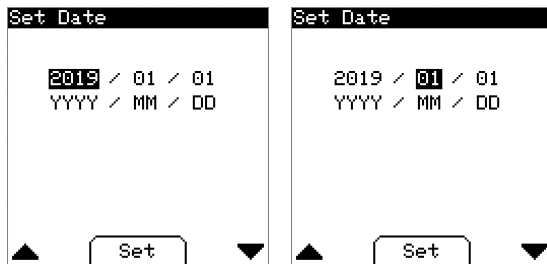

- Set Local Time:
  - This option sets the local time in HH:MM:SS format.
  - Use the up/down arrow keys to input the hours, minutes, seconds, and AM/PM (12 hour format).

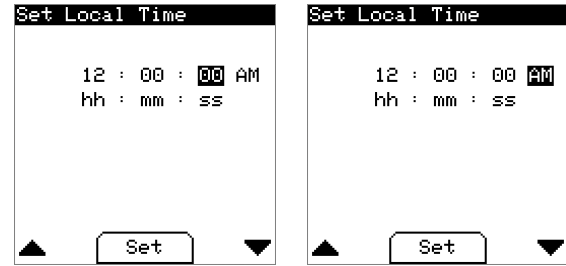
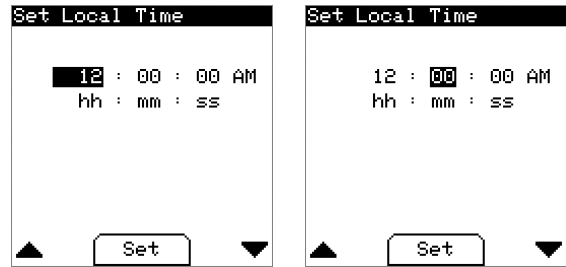

**Save Setup File**

- Create a setup file containing all the options and values selected from the wizards. This file is stored in the display and can be retrieved by connecting a USB cable (not included).



**Reset Total Flow**

- This menu allows the totalized flow value to be reset.

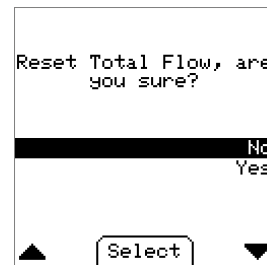

**Reset Energy Statistics**

- This menu allows the energy statistics to be reset.

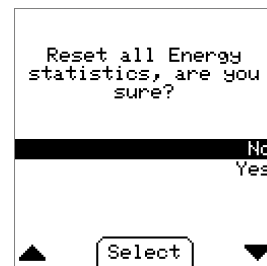

**Damping**

- This value determines the amount of time the velocity is averaged. The display value will reach 99% of the measured value within this time.
- Default: 30 s.



**Calibration Factor**

- This value sets a custom multiplier of the measured velocity.
- Default: 1.000.



**Save Defaults**

- This menu saves the current configuration as the user default values. This provides a means to save a known good configuration before making other changes.
- Default: Yes.

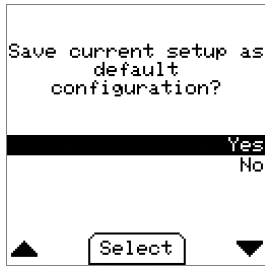

**Restore Defaults**

- This menu restores the saved user configuration to the current configuration. This provides a means to restore the meter to a known working state.
- Default: No.

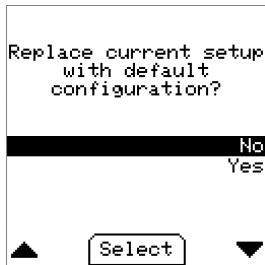

**Indicator Display Setup**

- If a remote indicator display is being used, select which values should be displayed.
- Default: V. Flow & Velocity

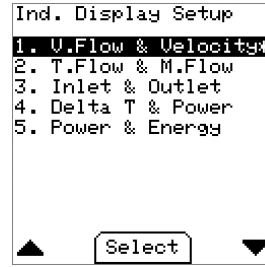

**Reset to Factory Default**

This special menu is accessed by press & holding ENTER and MENU buttons on the Device Information screen above. Answering Yes will reset all selections and values to factory default values.

**NOTICE** All BACnet Communications settings will be reset as well, including the values that can only be set via BACnet Communications.

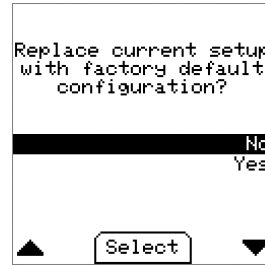

**Key Pad Lockout Feature**

- In units with the LCD option, a switch (shown in Figure 25) is located on the display board that locks out the keypad to prevent undesired key presses that could potentially change the meter configuration. When the switch is in the "locked" position, the display will generate a padlock symbol in the lower right corner as shown below.
- Default: Unlocked.

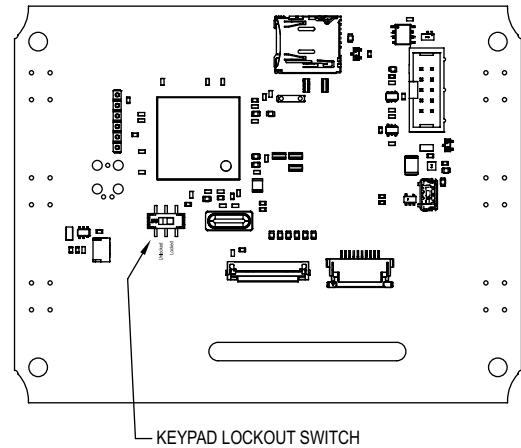
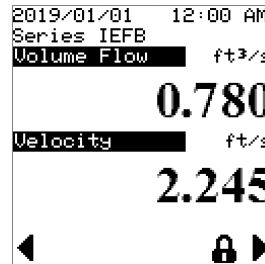

Figure 25: Keypad lockout switch

**Troubleshooting Guide**

A status blink code is conveyed by the blinking of the status LED (Figure 26) using the following parameters.

A blink is defined as the LED is ON for 200ms followed by the LED being OFF for 200ms.

If a status code has a tens digit, the tens digit blink code is created and then followed by a 750ms delay OFF time. Then the ones digit blink code is created.

After a blink code is displayed, there is an OFF time of 2 sec before the blink code is displayed again.

If more than one condition is true, the condition with the highest code will be displayed.

Example: Item 3, Invalid Factory Configuration with a blink code of 11. There would be a state of the LED being ON for 200 msec, then OFF for 200 msec, then OFF for 750 msec, then ON for 200 msec, then OFF for 200 msec followed by off for 2 sec before repeating this sequence.

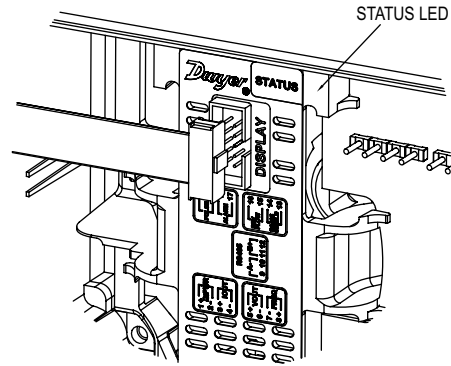
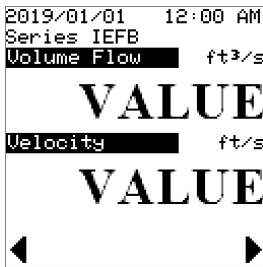
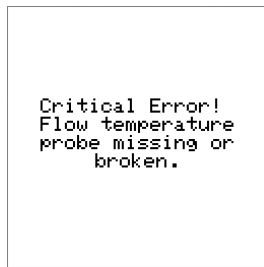

Figure 26: LED status blink

Item	Condition	Status LED Blink Code	Description	Corrective Action
1	Invalid value	1	Invalid calibration (Value display on LCD)	Return to factory, calibration required
2	Empty pipe	2	The probe is not submerged in the process fluid	Ensure the pipe is properly filled, ensure proper installation depth
3	Invalid factory configuration	11	The factory non-volatile configuration is invalid	Return to factory, configuration and calibration required
4	NV access failed	12	The meter failed to read its non-volatile memory	Return to factory for repair
5	NV write failed	13	The meter failed to write its non-volatile memory	Return to factory for repair
6	Wiring board not installed	21	The wiring board was not detected	Return to factory for repair
7	Flyback board not installed	22	The Flyback board was not detected	Return to factory for repair
8	Analog front end board not installed	24	The Analog Front End board was not detected	Return to factory for repair
9	Coil driver board not installed	25	The Coil Driver board was not detected	Return to factory for repair
10	Process temperature fault	26	Temperature sensor not responding	Return to factory for repair
11	Factory variable unlocked	33	The factory variables are unlocked and can be modified	Power cycle, reset, or send lock command to meter
12	Failure to measure process	n/a	Critical Error! Failed to measure process. (On-screen only)	Power cycle, reset via BACnet/Modbus®
13	Communication failure	n/a	Communication with the meter has failed. Settings not saved to meter (On-screen only)	Disconnect and reconnect display
14	Communication failure	n/a	Communication with meter has failed. Attempting to re-establish. Please wait ... (On-screen only)	Disconnect and reconnect display
15	Communication failure	n/a	Critical Error! Failed to access settings in non-volatile storage. (On-screen only)	Power cycle, reset via BACnet/Modbus®, consult factory
16	Settings not saved	n/a	Error: File Not Saved! Access Denied (On-screen only)	Disconnect and reconnect display, replace SD card on display PCBA
17	Settings not saved	n/a	Error: File Not Saved! Storage Media Timeout (On-screen only)	Disconnect and reconnect display, replace SD card on display PCBA
18	Settings not saved	n/a	Error: File Not Saved! Storage Media Not Ready (On-screen only)	Disconnect and reconnect display, replace SD card on display PCBA
19	Settings not saved	n/a	Error: File Not Saved! Storage Media Not Found (On-screen only)	Disconnect and reconnect display, replace SD card on display PCBA
20	Settings not saved	n/a	Error: File Not Saved! Unknown (On-screen only)	Verify SD card is fully inserted into SD card socket on display PCBA
21	Meter not configured	n/a	Meter not configured! The meter must be configured with a setup display before an indicator display can be used.	Configure setup display before connecting indicator display.
22	Temperature is outside range of expected value	n/a	Screen shows inlet and outlet temperatures as RANGE.	Reset temperature values input or check process
23	One or both of the RTD paths are open	n/a	Screen shows inlet and outlet temperatures as OPEN.	Return to factory for repair
24	One or both of the RTD paths are shorted	n/a	Screen shows inlet and outlet temperatures as SHORT.	Return to factory for repair



Item 1 Display



Item 10 Display

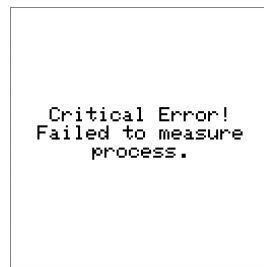

Item 12 Display



Item 13 Display



Item 14 Display



Item 15 Display



Item 16 Display



Item 17 Display



Item 18 Display



Item 19 Display



Item 20 Display

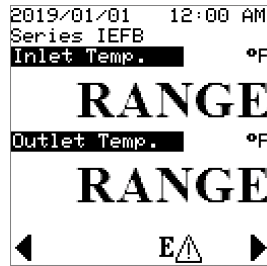

Item 21 Display

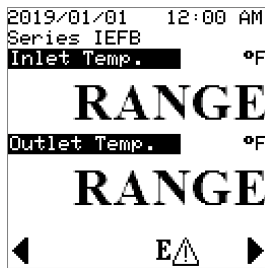

Item 22 Display

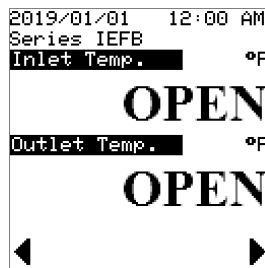

Item 23 Display



Item 24 Display

**Flow Condition Warnings:**

If a reverse flow condition exists, an "R" with an exclamation mark in a triangle will appear as shown below:

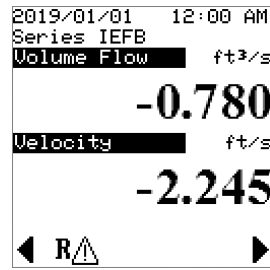

If an empty pipe condition exists, an "E" with an exclamation mark in a triangle will appear as shown below:

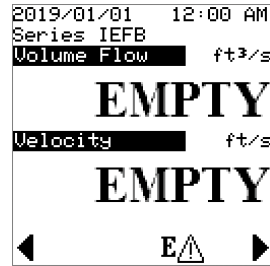

If velocity alarm condition exists a "V" with an exclamation mark in a triangle will appear as shown below:

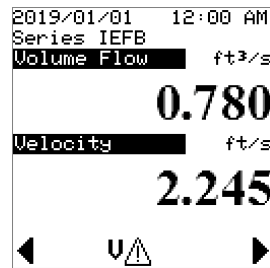

**MAINTENANCE/REPAIR**

Upon final installation of the Series IEFB, no routine maintenance is required. If recalibration is desired the unit must be returned to Dwyer Instruments, Inc. to be calibrated. Contact customer service to receive a Return Goods Authorization number before shipping your product back for calibration. The Series IEFB is not field serviceable and should be returned if repair is needed. Field repair should not be attempted and may void the warranty.

If you find the IEFB is reading incorrectly, remove the unit from the pipe and ensure the probe is free of debris. If necessary, use a soft cloth to clean the probe.

**WARRANTY/RETURN**

Refer to "Terms and Conditions of Sale" in our catalog or on our website. Contact customer service to receive a Return Goods Authorization number before shipping your product back for repair. Be sure to include a brief description of the problem plus any relevant application notes.

